

ISSN 2518-1491 (Online),
ISSN 2224-5286 (Print)

ҚАЗАҚСТАН РЕСПУБЛИКАСЫ
ҰЛТТЫҚ ҒЫЛЫМ АКАДЕМИЯСЫНЫҢ

Д.В.СОКОЛЬСКИЙ АТЫНДАҒЫ «ЖАНАРМАЙ,
КАТАЛИЗ ЖӘНЕ ЭЛЕКТРОХИМИЯ ИНСТИТУТЫ» АҚ

Х А Б А Р Л А Р Ы

ИЗВЕСТИЯ

НАЦИОНАЛЬНОЙ АКАДЕМИИ НАУК
РЕСПУБЛИКИ КАЗАХСТАН

АО «ИНСТИТУТ ТОПЛИВА, КАТАЛИЗА И
ЭЛЕКТРОХИМИИ ИМ. Д.В. СОКОЛЬСКОГО»

NEWS

OF THE ACADEMY OF SCIENCES
OF THE REPUBLIC OF KAZAKHSTAN

JSC «D.V. SOKOLSKY INSTITUTE OF FUEL,
CATALYSIS AND ELECTROCHEMISTRY»

ХИМИЯ ЖӘНЕ ТЕХНОЛОГИЯ СЕРИЯСЫ



СЕРИЯ ХИМИИ И ТЕХНОЛОГИИ



SERIES CHEMISTRY AND TECHNOLOGY

3 (429)

МАМЫР – МАУСЫМ 2018 ж.

МАЙ – ИЮНЬ 2018 г.

MAY – JUNE 2018

1947 ЖЫЛДЫҢ ҚАҢТАР АЙЫНАН ШЫҒА БАСТАҒАН
ИЗДАЕТСЯ С ЯНВАРЯ 1947 ГОДА
PUBLISHED SINCE JANUARY 1947

ЖЫЛЫНА 6 РЕТ ШЫҒАДЫ
ВЫХОДИТ 6 РАЗ В ГОД
PUBLISHED 6 TIMES A YEAR

NAS RK is pleased to announce that News of NAS RK. Series of chemistry and technologies scientific journal has been accepted for indexing in the Emerging Sources Citation Index, a new edition of Web of Science. Content in this index is under consideration by Clarivate Analytics to be accepted in the Science Citation Index Expanded, the Social Sciences Citation Index, and the Arts & Humanities Citation Index. The quality and depth of content Web of Science offers to researchers, authors, publishers, and institutions sets it apart from other research databases. The inclusion of News of NAS RK. Series of chemistry and technologies in the Emerging Sources Citation Index demonstrates our dedication to providing the most relevant and influential content of chemical sciences to our community.

Қазақстан Республикасы Ұлттық ғылым академиясы "ҚР ҰҒА Хабарлары. Химия және технология сериясы" ғылыми журналының Web of Science-тің жаңаланған нұсқасы Emerging Sources Citation Index-те индекстелуге қабылданғанын хабарлайды. Бұл индекстелу барысында Clarivate Analytics компаниясы журналды одан әрі the Science Citation Index Expanded, the Social Sciences Citation Index және the Arts & Humanities Citation Index-ке қабылдау мәселесін қарастыруда. Web of Science зерттеушілер, авторлар, баспашылар мен мекемелерге контент тереңдігі мен сапасын ұсынады. ҚР ҰҒА Хабарлары. Химия және технология сериясы Emerging Sources Citation Index-ке енуі біздің қоғамдастық үшін ең өзекті және беделді химиялық ғылымдар бойынша контентке адалдығымызды білдіреді.

НАН РК сообщает, что научный журнал «Известия НАН РК. Серия химии и технологий» был принят для индексирования в Emerging Sources Citation Index, обновленной версии Web of Science. Содержание в этом индексировании находится в стадии рассмотрения компанией Clarivate Analytics для дальнейшего принятия журнала в the Science Citation Index Expanded, the Social Sciences Citation Index и the Arts & Humanities Citation Index. Web of Science предлагает качество и глубину контента для исследователей, авторов, издателей и учреждений. Включение Известия НАН РК в Emerging Sources Citation Index демонстрирует нашу приверженность к наиболее актуальному и влиятельному контенту по химическим наукам для нашего сообщества.

Б а с р е д а к т о р ы
х.ғ.д., проф., ҚР ҰҒА академигі **М.Ж. Жұрынов**

Р е д а к ц и я а л қ а с ы:

Ағабеков В.Е. проф., академик (Белорус)
Волков С.В. проф., академик (Украина)
Воротынцев М.А. проф., академик (Ресей)
Газалиев А.М. проф., академик (Қазақстан)
Ергожин Е.Е. проф., академик (Қазақстан)
Жармағамбетова А.К. проф. (Қазақстан), бас ред. орынбасары
Жоробекова Ш.Ж. проф., академик (Қырғыстан)
Иткулова Ш.С. проф. (Қазақстан)
Манташян А.А. проф., академик (Армения)
Пралиев К.Д. проф., академик (Қазақстан)
Баешов А.Б. проф., академик (Қазақстан)
Бүркітбаев М.М. проф., академик (Қазақстан)
Джусипбеков У.Ж. проф. корр.-мүшесі (Қазақстан)
Молдахметов М.З. проф., академик (Қазақстан)
Мансуров З.А. проф. (Қазақстан)
Наурызбаев М.К. проф. (Қазақстан)
Рудик В. проф., академик (Молдова)
Рахимов К.Д. проф. академик (Қазақстан)
Стрельцов Е. проф. (Белорус)
Тәшімов Л.Т. проф., академик (Қазақстан)
Тодераш И. проф., академик (Молдова)
Халиков Д.Х. проф., академик (Тәжікстан)
Фарзалиев В. проф., академик (Әзірбайжан)

«ҚР ҰҒА Хабарлары. Химия және технология сериясы».

ISSN 2518-1491 (Online),

ISSN 2224-5286 (Print)

Меншіктенуші: «Қазақстан Республикасының Ұлттық ғылым академиясы» Республикалық қоғамдық бірлестігі (Алматы қ.)

Қазақстан республикасының Мәдениет пен ақпарат министрлігінің Ақпарат және мұрағат комитетінде 30.04.2010 ж. берілген №1089-Ж мерзімдік басылым тіркеуіне қойылу туралы куәлік

Мерзімділігі: жылына 6 рет.

Тиражы: 300 дана.

Редакцияның мекенжайы: 050010, Алматы қ., Шевченко көш., 28, 219 бөл., 220, тел.: 272-13-19, 272-13-18,
www.nauka-nanrk.kz / chemistry-technology.kz

© Қазақстан Республикасының Ұлттық ғылым академиясы, 2018

Типографияның мекенжайы: «Аруна» ЖК, Алматы қ., Муратбаева көш., 75.

Г л а в н ы й р е д а к т о р
д.х.н., проф., академик НАН РК **М. Ж. Журинов**

Р е д а к ц и о н н а я к о л л е г и я:

Агабеков В.Е. проф., академик (Беларусь)
Волков С.В. проф., академик (Украина)
Воротынцев М.А. проф., академик (Россия)
Газалиев А.М. проф., академик (Казахстан)
Ергожин Е.Е. проф., академик (Казахстан)
Жармагамбетова А.К. проф. (Казахстан), зам. гл. ред.
Жоробекова Ш.Ж. проф., академик (Кыргызстан)
Иткулова Ш.С. проф. (Казахстан)
Манташян А.А. проф., академик (Армения)
Пралиев К.Д. проф., академик (Казахстан)
Баешов А.Б. проф., академик (Казахстан)
Буркитбаев М.М. проф., академик (Казахстан)
Джусипбеков У.Ж. проф. чл.-корр. (Казахстан)
Мулдахметов М.З. проф., академик (Казахстан)
Мансуров З.А. проф. (Казахстан)
Наурызбаев М.К. проф. (Казахстан)
Рудик В. проф., академик (Молдова)
Рахимов К.Д. проф. академик (Казахстан)
Стрельцов Е. проф. (Беларусь)
Ташимов Л.Т. проф., академик (Казахстан)
Тодераш И. проф., академик (Молдова)
Халиков Д.Х. проф., академик (Гаджикистан)
Фарзалиев В. проф., академик (Азербайджан)

«Известия НАН РК. Серия химии и технологии».

ISSN 2518-1491 (Online),

ISSN 2224-5286 (Print)

Собственник: Республиканское общественное объединение «Национальная академия наук Республики Казахстан» (г. Алматы)

Свидетельство о постановке на учет периодического печатного издания в Комитете информации и архивов Министерства культуры и информации Республики Казахстан №10893-Ж, выданное 30.04.2010 г.

Периодичность: 6 раз в год

Тираж: 300 экземпляров

Адрес редакции: 050010, г. Алматы, ул. Шевченко, 28, ком. 219, 220, тел. 272-13-19, 272-13-18,
<http://nauka-nanrk.kz / chemistry-technology.kz>

© Национальная академия наук Республики Казахстан, 2018

Адрес редакции: 050100, г. Алматы, ул. Кунаева, 142,
Институт органического катализа и электрохимии им. Д. В. Сокольского,
каб. 310, тел. 291-62-80, факс 291-57-22, e-mail: orgcat@nursat.kz

Адрес типографии: ИП «Аруна», г. Алматы, ул. Муратбаева, 75

E d i t o r i n c h i e f

doctor of chemistry, professor, academician of NAS RK **M.Zh. Zhurinov**

E d i t o r i a l b o a r d :

Agabekov V.Ye. prof., academician (Belarus)
Volkov S.V. prof., academician (Ukraine)
Vorotyntsev M.A. prof., academician (Russia)
Gazaliyev A.M. prof., academician (Kazakhstan)
Yergozhin Ye.Ye. prof., academician (Kazakhstan)
Zharmagambetova A.K. prof. (Kazakhstan), deputy editor in chief
Zhorobekova Sh.Zh. prof., academician (Kyrgyzstan)
Itkulova Sh.S. prof. (Kazakhstan)
Mantashyan A.A. prof., academician (Armenia)
Praliyev K.D. prof., academician (Kazakhstan)
Bayeshov A.B. prof., academician (Kazakhstan)
Burkitbayev M.M. prof., academician (Kazakhstan)
Dzhusipbekov U.Zh. prof., corr. member (Kazakhstan)
Muldakhmetov M.Z. prof., academician (Kazakhstan)
Mansurov Z.A. prof. (Kazakhstan)
Nauryzbayev M.K. prof. (Kazakhstan)
Rudik V. prof., academician (Moldova)
Rakhimov K.D. prof., academician (Kazakhstan)
Streltsov Ye. prof. (Belarus)
Tashimov L.T. prof., academician (Kazakhstan)
Toderash I. prof., academician (Moldova)
Khalikov D.Kh. prof., academician (Tadjikistan)
Farzaliyev V. prof., academician (Azerbaijan)

News of the National Academy of Sciences of the Republic of Kazakhstan. Series of chemistry and technology.
ISSN 2518-1491 (Online),
ISSN 2224-5286 (Print)

Owner: RPA "National Academy of Sciences of the Republic of Kazakhstan" (Almaty)

The certificate of registration of a periodic printed publication in the Committee of Information and Archives of the Ministry of Culture and Information of the Republic of Kazakhstan N 10893-Ж, issued 30.04.2010

Periodicity: 6 times a year

Circulation: 300 copies

Editorial address: 28, Shevchenko str., of. 219, 220, Almaty, 050010, tel. 272-13-19, 272-13-18,
<http://nauka-nanrk.kz/chemistry-technology.kz>

© National Academy of Sciences of the Republic of Kazakhstan, 2018

Editorial address: Institute of Organic Catalysis and Electrochemistry named after D. V. Sokolsky
142, Kunayev str., of. 310, Almaty, 050100, tel. 291-62-80, fax 291-57-22,
e-mail: orgcat@nursat.kz

Address of printing house: ST "Aruna", 75, Muratbayev str, Almaty

NEWS

OF THE NATIONAL ACADEMY OF SCIENCES OF THE REPUBLIC OF KAZAKHSTAN

SERIES CHEMISTRY AND TECHNOLOGY

ISSN 2224-5286

Volume 3, Number 429 (2018), 6 – 12

UDC 541.13+621.383+541.64

K.A. Urazov^{1,2}, M.B. Dergacheva², V.F. Gremenok³

¹Kazakh-British Technical University, Almaty, Kazakhstan;

²D.V. Sokolsky Institute of Fuel, Catalysis and Electrochemistry, Almaty, Kazakhstan;

³Scientific-Practical Materials Research Centre of the NAS of Belarus, Minsk, Belarus

INVESTIGATION OF THE SURFACE MORPHOLOGY OF POLYANILINE THIN FILMS

Abstract. The surface and optical properties of polyaniline thin films on a conducting FTO/glass substrate are determined. The thin films were prepared by anodic oxidative polymerization of aniline in the galvanostatic regime from hydrochloric acid solutions containing aniline and poly-2-acrylamido-2-methyl-1-propanesulfonic acid. The thickness of the thin films was 20 and 60 nm. Thin films were characterized by the methods of XRD, SEM, ACM. An insignificant change in the structure of the glass substrate during the application of the polyaniline has been established. Thin films consist of particles with different diameters are distinguished, the maximum of which is 250 nm. The some of the particles has a diameter of 50-70 nm. Thin films with 60 nm thickness have a dense and uniform surface. Its roughness and position of individual grains, as well as the surface profile, are determined by atomic force microscopy. Optical properties of coatings are determined by UV spectroscopy. On the basis of the studies performed, it was concluded that the absorbing capacity of glass coated with polyaniline increases more in the red wavelength region. Surface roughness increases with increasing thin films thickness. However, as follows from the SEM micrographs, the density and uniformity of the thin films increase when the thickness of the electrodeposited layer is 60 nm. The width of the band gap of the polyaniline/FTO/glass system is 3.85 eV.

Key words: Polyaniline, electrodeposition, thin film, surface morphology, transmission spectrum.

Introduction

Polyaniline (PANI) is one of the representatives of the class of electrically conductive polymers. The study of polyaniline, as well as other polymer compounds, such as polythiophene, polyacetylene, polyparaphenylenevinylene, polypyrrole, showed that they possess semiconductor properties [1-3]. PANI has good electronic conductivity, thermal and ecological stability, low cost [4]. The structural formula of polyaniline is shown in Fig. 1. PANI can be synthesized both by chemical and electrochemical methods [4,5]. Due to its physical and chemical properties, PANI is an attractive conductive polymer and is used in a wide range of applications, such as batteries [5], diodes and photovoltaic cells [6].

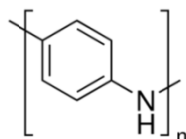

Figure 1 - The structural formula of polyaniline

Polyaniline was one of the earliest polymers used as a hole buffer layer in a photovoltaic device of organic/silicon [7,8].

Buffer layers are considered essential elements of organic photovoltaic devices with a bulk heterojunction. These additional layers, called buffer layers or interphase layers or interlayers, in solar cells can perform the function of collecting and extracting charges. For this purpose, the structure of the

organic solar cell can include both an anode buffer layer for collecting holes and a cathode buffer layer for collecting electrons. In this context, PANI is a very good hole collector and has good conductivity, which makes it an interesting material for research in the field of photovoltaics [9].

In this paper, we propose a method for the electrochemical polymerization of aniline in order to obtain film coatings of PANI that can serve as a buffer layer for transporting holes in solar cells

Experimental part

Polyaniline (PANI) films were obtained by anodic oxidative polymerization of aniline in the galvanostatic regime (0.05 mA/cm²). Precipitation was carried out on purified glass electrodes coated with a transparent conductive SnO₂:F (FTO/glass) layer with a surface resistance of 7 ohms/cm² and a working surface area of 3 cm². The counter electrode was platinum foil, and the reference electrode was a saturated silver chloride electrode (SCE). In the case of electropolymerization, the concentration of aniline was 0.05 M, HCl 0.5 M and poly-2-acrylamido-2-methyl-1-propanesulfonic acid (PAMPSK) 0.001 M.

Electrochemical polymerization of aniline was carried out in a special three-electrode cell using a potentiostat/galvanostat HA-501G (Hokuto Denko Ltd.). Electrodeposition of PANI on FTO/glass substrates was conducted until a charge of 15 mC/cm² was reached, where the layer thickness was about 60 nm and until a charge of 7mC/cm² was reached, where the layer thickness was about 20 nm. At the end of the electropolymerization, the obtained samples were washed with distilled water and dried in air.

XRD spectra were obtained using an X-ray diffractometer SmartLab (Rigaku) at a constant voltage of 9 kW using a rotating Cu anode for investigating the structure obtained PANI thin films.

Surface and cross-sectional micrographs were obtained using a Helios NanoLab 650 (FEI) scanning electron microscope with Schottkytype field emission electron source, focused gallium ion source (FIB). To obtain a cross-sectional image, a platinum (Pt) layer is first applied to the selected area and then a section is performed next to the platinum. The length, width and height of the platinum layer can be up to 20x2x1 μm, respectively. And the depth of section can reach 4 μm.

The morphology of the surface of PANI thin films was examined using an atomic force microscope JSPM 5200 (JEOL Ltd.). Scanning to AFM was carried out at atmospheric pressure and room temperature in a semi-contact method using an NSC 35 AIBS cantilever with a radius of curvature of 10 nm.

The optical properties of the obtained samples were studied with the SF-256 UVI spectrometer, with the possibility of recording the transmission coefficient in the wavelength range from 190 nm to 1100 nm.

Results and discussion

The PANI polymer has an amorphous structure. To determine the possible change in the structure of the coating on the FTO/glass substrate, the X-ray diffraction patterns of the conducting substrate -with and -without PANI were compared (Fig. 2). Figure 1 shows the X-ray diffraction pattern of a sample with a PANI thin film, which shows that new noticeable reflexes appear in the angular region $2\theta = 24 \div 26^\circ$, which are in good agreement with the data obtained in [10, 11].

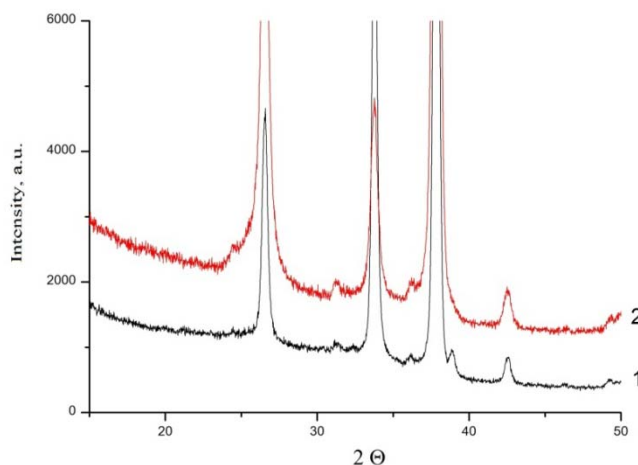
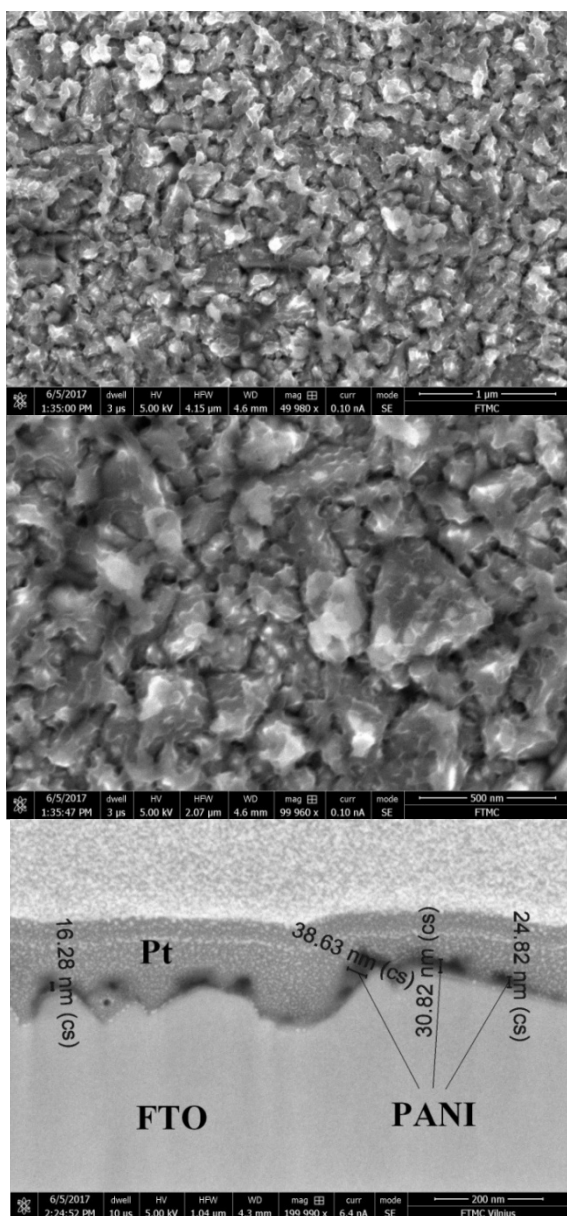

Figure 2—The XRD pattern of FTO/glass substrate with (2) and without (1) PANI

Figure 3 shows SEM images of the surface of the obtained films and shows that the film is formed by particles of various shapes and sizes. In the thin layer of the PANI (Fig. 3a) are well expressed the verges of the formed particles and their homogeneity in shape. Some reach a diameter of 200-250 nm, but the main array of particle's diameter is 50-70 nm. Increasing the thickness of the layer to 60 nm leads to uniform coating of the glass (Fig. 3b) without the formation of separate conglomerates, dendrites or globules.

Cross-sectional microphotographs show that the thickness of the PANI films varies from 16 nm to 38 nm (Fig. 3a) and from 42 nm to 77 nm (Fig. 3b).



a) the thickness of the layer is 20 nm

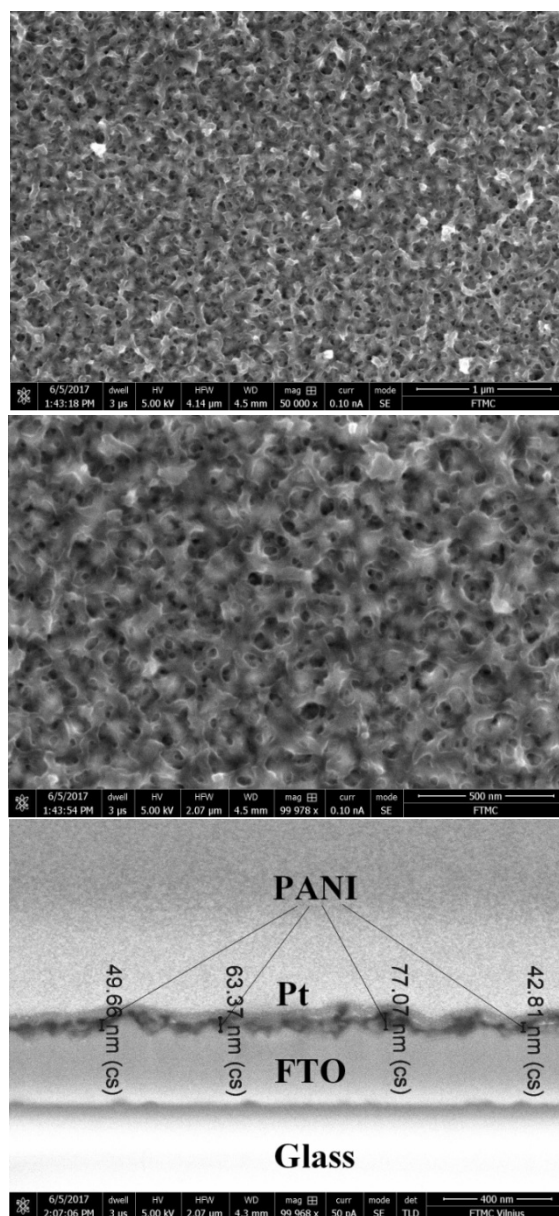

b) the thickness of the layer is 60 nm

Figure3–SEM images of PANI thin films surface and cross-section

Figure 4a,b show surface micrographs obtained by atomic-force microscopy in various scan size. As shown in Figure 4a, PANI film with a thickness of 20 nm is formed from small and large particles of various shapes. The surface morphology of the film has a granular structure. There is heterogeneity in some areas, like pores between individual particles.

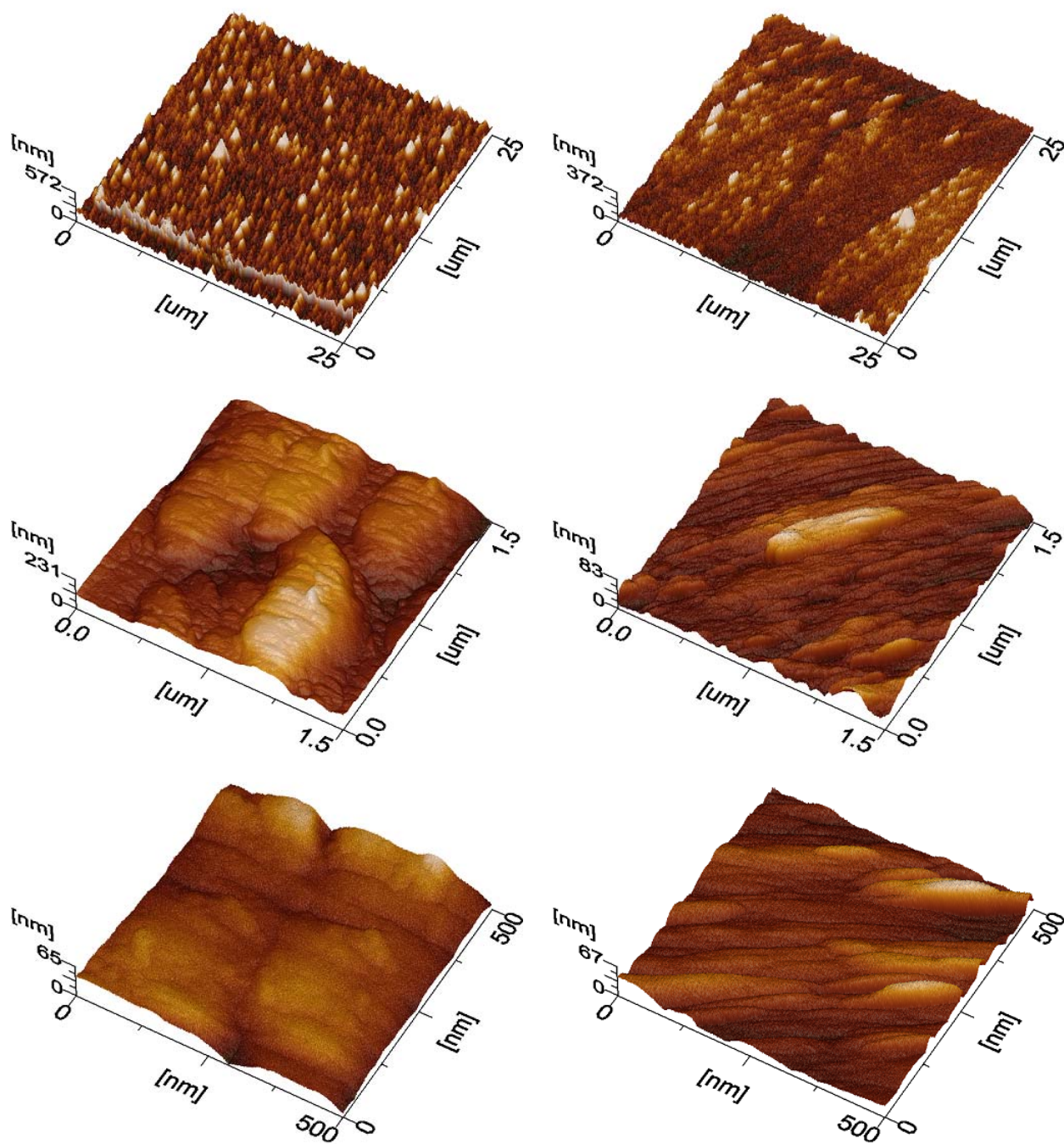

a) the thickness of the layer is 20 nm

б) the thickness of the layer is 60 nm

Figure 4– AFM images of PANI thin films at various scan size: 25x25 μm, 1,5x1,5 μm, 0,5x0,5 μm

This fact indicates that the roughness of the FTO/glass substrate affects to the microrelief of the polymer film, if the thickness of the latest is 20 nm.

The analysis of AFM images of PANI films with a thickness of 60 nm showed that the polymer layer has a granular structure with uniform surface coverage. The film is formed from more homogeneous particles, which's average length is 50-150 nm.

AFM images show, that there are the differences between films of different thickness (Fig.4a,b). The surface of the PANI film 60 nm thick has a more uniform and fine-grained structure than a film with a thickness of 20 nm.

Roughness parameters of electrodeposited PANI films with 60 nm thickness are shown in Figure 5 as an image surface and information about the parameters of the particles on a selected area.

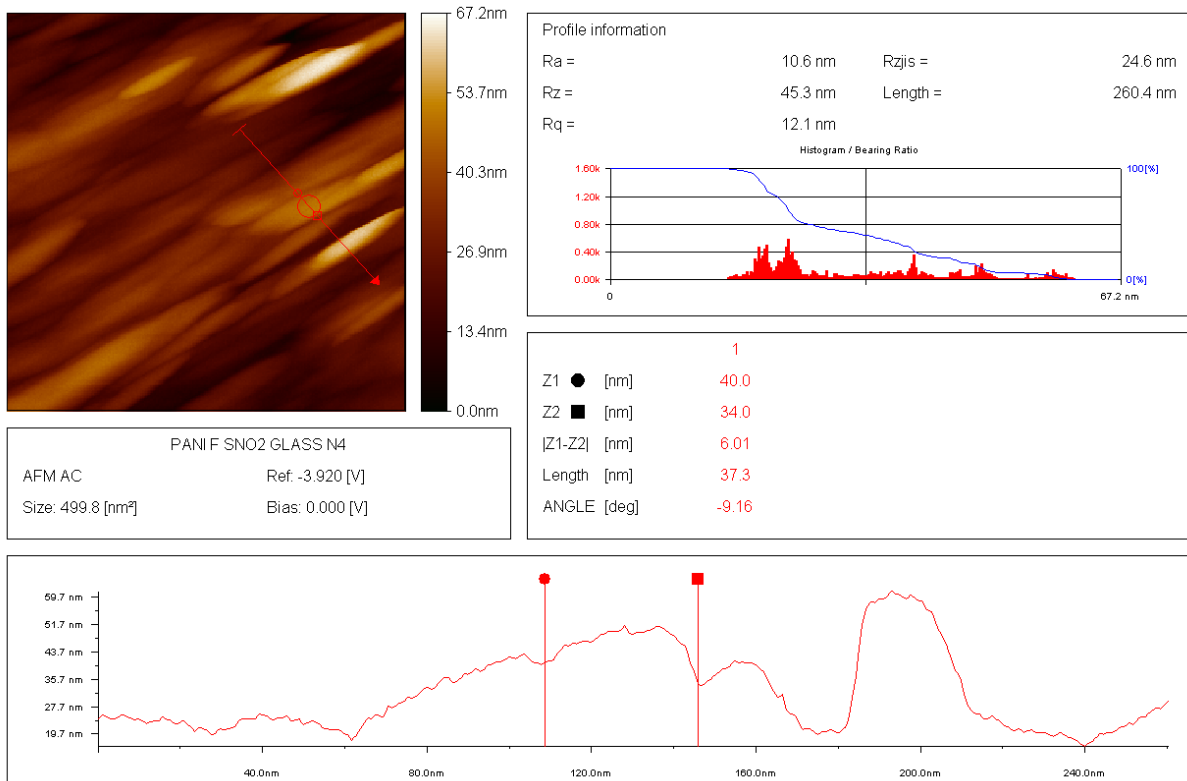

Figure 5 –AFM image and graph of PANI’s particles size distribution for the selected surface area (500x500 nm)

Figure 6 shows the histograms of the particle distribution on the selected area 500x500 nm and the isolated square 250x250 nm.

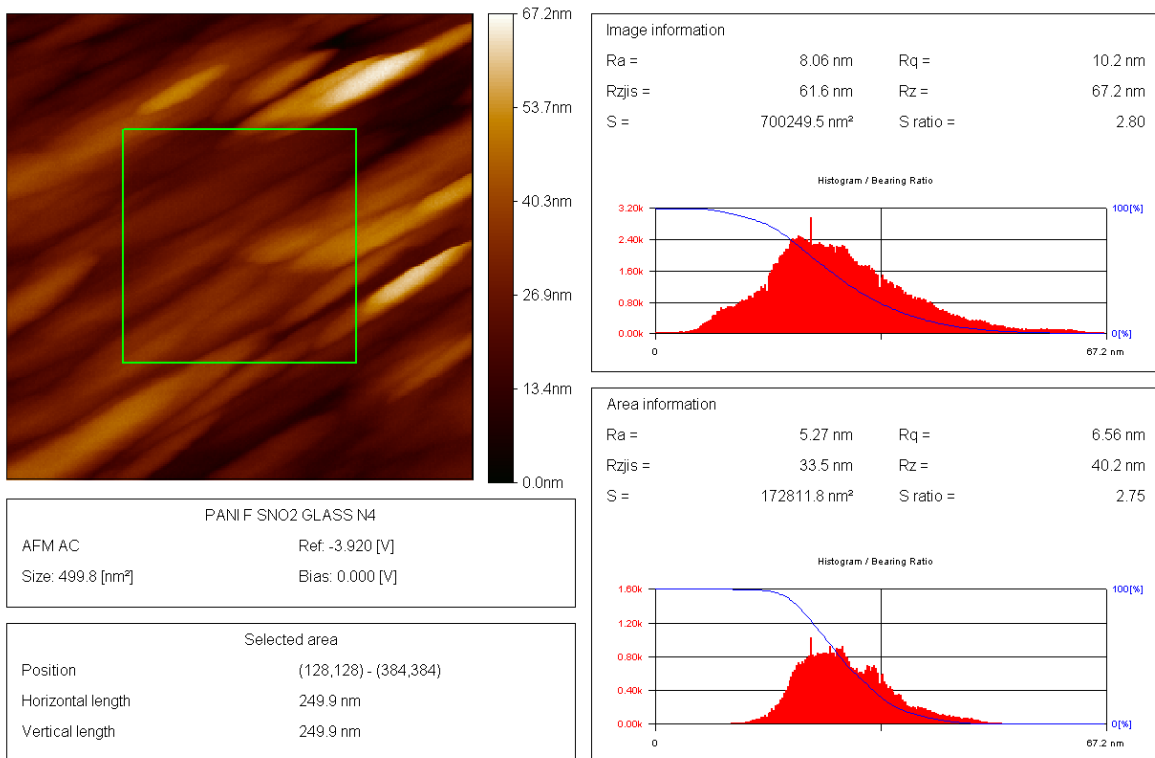

Figure 6 –AFM image of PANI thin film and histograms of the particle distribution on the selected area (500x500 nm) and the isolated square (250x250 nm)

The roughness parameters of the surface of PANI film at the selected area (500x500 nm) are shown in Table 1.

Table 1 – Parameters of the surface structure of PANI thin films on FTO/glass substrate

R_a , nm average roughness	$R_{z_{iis}}$, nm average roughness of 10 points	R_q , nm square root of square roughness	R_z , nm the difference between the maximum and minimum height of the analyzed image	
10,6	24,6	12,1	45,3	Fig.5
8,06	61,6	10,2	67,2	Fig.6

The obtained results attest to the high quality of PANI films obtained by electrodeposition on a conducting glass.

An important optical parameter for the characteristics of a semiconductor compound is the size of the band gap. This value for electrodeposited PANI films was determined on the basis of the transmission spectra obtained with the spectrometer CF-256-UVI.

Figure 7 shows the transmission spectra for the FTO/glass substrate and the PANI coated substrates. As shown in Fig. 7, the edge of the absorption band corresponds to a wavelength of 460 nm. In the visible region of 400-700 nm, the transmittance is maximal, and when shifted to the red and infrared regions, PANI coated glass absorbs more radiation and the transmittance decreases to almost 50%.

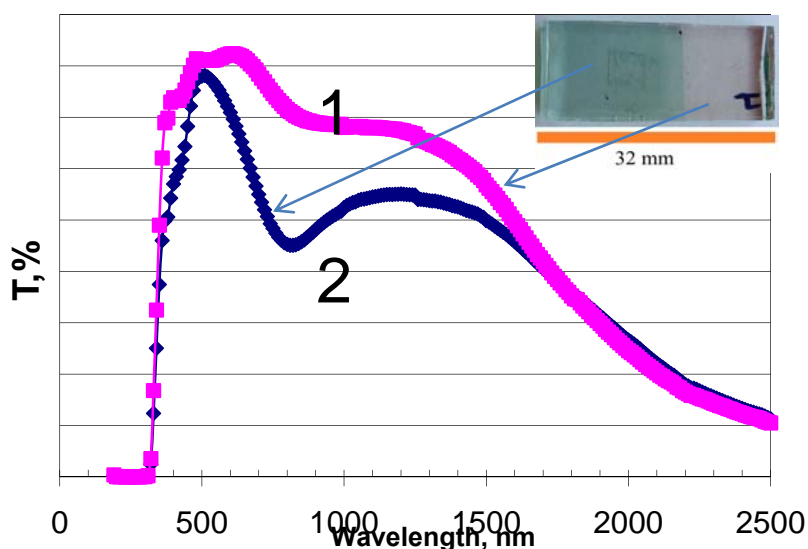

Figure 7 – Transmission specters of FTO/glass (1) and PANI/FTO/glass (2)

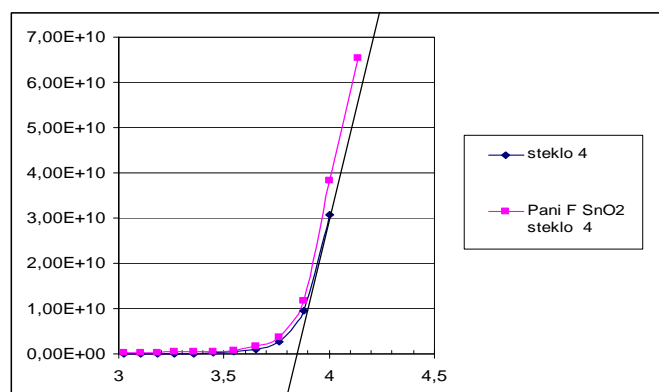

Figure 8 – Graph of the transmission coefficient versus wave energy

The dependence of the transmittance on the energy of the wave is shown in Fig. 8. According to this dependence, the width of the band gap for glass with and without coating is determined by the value on the abscissa axis cut off by the tangent and is 3.85 eV. The difference for both samples is insignificant.

Conclusion

Based on the investigations it was concluded that the absorption capacity of PANI coated glass increases more in the red region of wavelengths. Surface roughness increases with increasing coating thickness. However, as shown in SEM micrographs, the density and uniformity of the coating increase when the thickness of the electrodeposited layer is 60 nm.

Acknowledgments

The authors are grateful to the staff of the Laboratory "Electronic and Photon Processes in Polymer Nanomaterials". A.N. Frumkin RAS (Moscow) under the direction of Dr. Tameeva A.R., in which experiments on the electrodeposition of polyaniline were performed. The work was carried out under the grant of MES RK AP05130392.

REFERENCES

- [1] Skotheim T.A., Ronald L.E., Reynolds J.R. Handbook of Conducting Polymers. 2nd edn. New York: CRC Press, 1997. 1120 pages. (in Eng.)
- [2] Bhattacharya A. and De A. Conducting composites of polypyrrole and polyaniline – A review // Prog. Solid State Chem. 1996. №24, P.141-181. (in Eng.)
- [3] Rodriguez J., Grande H.J., Otero T.F. Handbook of Organic Conductive Molecules and Polymers. New York: John Wiley & Sons, 1997. 3334 pages. (in Eng.)
- [4] Inzelt G. Conducting Polymers. 2nd edn. Berlin: Springer, 2012. 310 pages. (in Eng.)
- [5] MacDiarmid A.G., Yang L.S., Huang W.S., Humphrey B.D. Polyaniline: electrochemistry and application to rechargeable batteries // Synth. Met. 1987. №18. P.393-398. (in Eng.)
- [6] Sariciftci N.S., Braun D., Zhang C., Srdanov V.I., Heeger A.J., Stucky G., Wudl F. Semiconducting polymer-buckminsterfullerene heterojunctions – diodes, photodiodes, and photovoltaic cells // Appl. Phys. Lett. 1993. №62. P.585-587. (in Eng.)
- [7] Renkuan Y., Hong Y., Zheng Z., Youdou Z., Yongnan W., Polyaniline/silicon heterojunctions // Synth. Met. 1991. №41. P.731-734. (in Eng.)
- [8] Renkuan Y., Yuxue L., Hong Y., Yongbin W., Xiangqin Z., Jian X., Xuechu S. Study of photoelectric characteristics of p-PAN/n-Si junction // Synth. Met. 1993. №57. P. 4087-4092. (in Eng.)
- [9] Choy W. C. H. (ed.). Organic Solar Cells. London: Springer, 2013. 266 pages. (in Eng.)
- [10] Chaudhari H. K. and Kelkar D. S. X-ray diffraction study of doped polyaniline // J. Appl. Polym. Sci. 1996. №62. P.15-18. (in Eng.)
- [11] Manivel P., et al. Optical and electrochemical studies of polyaniline/SnO₂ fibrous nanocomposites // Materials Research Bulletin, 2013. V.48. №2. P.640-645. (in Eng.)

К.А. Уразов, М.Б. Дергачева, В.Ф. Гременок

ПОЛИАНАЛИН ҚАБЫҚШАЛАРЫНЫҢ БЕТКІ МОРФОЛОГИЯСЫН ЗЕРТТЕУ

Аннотация. Жұмыста электрохимиялық жолмен қалыңдығы 20 және 60 нм болатын ПАНИ жұқа қабықтары өткізгіш FTO/шыны төсеніштерінде алынғаны көрсетілді. Алынған ПАНИ қабықшаларының құрылымы мен беткі морфологиясы РФА, СЭМ, АСМ әдістерінің көмегімен зерттелді. Шыны төсеніштерді полианилинмен қаптаған кезде, олардың құрылымы кішкене өзгертіні анықталды. Жұқа қабықшалардың бөлшектері әртүрлі өлшемді екені және олардың ең үлкені 250 нм болатыны анықталды. Қалыңдығы 60 нм қабықшалардың беті тығыз біртекті болып келеді. Оның кедір-бұдыры және кейбір бөлшектердің орны, сонымен қатар беткі профилі атомды күш микроскопия әдісімен анықталды. Оптикалық қасиеттері УФ-спектроскопия әдісімен анықталды. Орындалған зерттеулердің негізінде полианилинмен қапталған шынының сіңіру қабілеті толқын ұзындығының қызыл аймағында жоғарлайтыны туралы қорытынды жасалды. Дайындалған ПАНИ/FTO/шыны жүйесінің рұқсат етілмеген аумағының өлшемі 3,85 эВ болатыны анықталды.

Түйін сөздер: Полианилин, электротұндыру, жұқа қабық, беткі морфология, өткізгіштік спектрі.

К.А. Уразов, М.Б. Дергачева, В.Ф. Гременок

ИССЛЕДОВАНИЕ МОРФОЛОГИИ ПОВЕРХНОСТИ ПЛЕНОК ПОЛИАНАЛИНА

Аннотация. В работе показан электрохимический способ получения тонких пленок полианилина (ПАНИ) с толщиной 20 и 60 нм на FTO/стекло подложках. Структура и морфология поверхности полученных пленок ПАНИ исследовали с помощью методов РФА, СЭМ, АСМ. Установлено незначительное изменение структуры стеклянной подложки при нанесении полианилина. На тонких покрытиях выделены частицы с различными диаметрами, максимальный из которых составляет 250 нм. Покрытия толщиной 60 нм представляют собой плотную однородную поверхность. Ее шероховатость и положение отдельных зерен, а также профиль поверхности определены методом атомной силовой микроскопии. Оптические свойства покрытий определены методом УФ-спектроскопии. На основании выполненных исследований сделан вывод, что поглощающая способность стекла, покрытого полианилином увеличивается больше в красной области длин волн. Ширина запрещенной зоны системы ПАНИ/FTO/стекло составляет 3,85 эВ.

Ключевые слова: Полианилин, электроосаждение, тонкая пленка, морфология поверхности, спектр пропускания.

NEWS

OF THE NATIONAL ACADEMY OF SCIENCES OF THE REPUBLIC OF KAZAKHSTAN
SERIES CHEMISTRY AND TECHNOLOGY

ISSN 2224-5286

Volume 3, Number 429 (2018), 13 – 19

UDC 542.943; 547.211;661.961;661.993

**S.A. Tungatarova^{1,2}, G. Xanthopoulou³, T.S. Baizhumanova¹, M. Zhumabek¹,
G.N. Kaumenova^{1,2}, N.A. Amrenova², A.K. Salimanova⁴, A. Raiyssov²**¹JSC “D.V. Sokolsky Institute of Fuel, Catalysis and Electrochemistry”, Almaty, Kazakhstan²Al-Farabi Kazakh National University, Almaty, Kazakhstan³Institute of Nanoscience and Nanotechnology, NCSR Demokritos, Athens, Greece⁴K. Zhubanov Aktobe Regional State University, Aktobe, Kazakhstantungatarova58@mail.ru**DRY REFORMING AND OXIDATIVE CONVERSION OF METHANE
TO SYNTHESIS GAS IN THE PRESENCE OF Ni-Co-Mg-Ce CATALYSTS**

Abstract. Catalytic carbon dioxide conversion of methane is the preferred method for producing synthesis gas in connection with the implementation of the process under milder conditions and solving environmental problems associated with a decrease in the rate of global warming. The activity of catalysts based on Ni-Co-Mg-Ce, obtained during combustion in solution, was studied in the processes of carbon dioxide conversion and oxidative conversion of methane. Comparative results indicate that the preparation of the catalyst by the impregnation method is inferior to the SHS method, in which higher values of the feed conversion and H₂ yield are obtained.

Key words: dry reforming, self-propagating high-temperature synthesis, methane, synthesis gas.

Introduction

Over the past two decades, the catalytic carbon dioxide conversion of methane to synthesis gas has attracted increasing attention as an alternative way for obtaining of synthesis gas (CO + H₂) by reaction $\text{CH}_4 + \text{CO}_2 \rightarrow 2\text{CO} + 2\text{H}_2$ [1-9]. This process is an attractive industrial process because of the low ratio of H₂/CO products and is therefore preferable for the Fischer-Tropsch process. According to the analysis of the energy prospects of the International Energy Agency (IEA) in 2013, "natural gas will certainly play a central role in meeting global energy needs, at least in the next two and a half decades." This means that technologies based on methane will have priority in the future.

Since 1950, methane production has doubled and could double by 2050. Annually 350-500 million tons of methane is added to the air (livestock, coal mining, oil and natural gas production, rice cultivation, garbage in landfills). Global annual emissions of anthropogenic greenhouse gases (by CO₂) are estimated at around 75%, and methane - around 14%. Reducing emissions of CH₄ and CO₂ can reduce global warming, reducing the risk of climate change. One way of doing this is catalytic reforming of methane with carbon dioxide to produce synthesis gas.

Many researchers have found that catalysts based on Fe, Co and Ni have a high activity, but one of the main problems arising during the application of this process is deactivation of catalyst mainly due to the deposition of carbon. Over the past decades, nickel catalysts have been extensively studied [10-12], a few studies have been done on cobalt catalysts, Ni-Co catalysts [13,14], and Ni-Ce-based catalysts [15-20]. It is known that the catalysts detected during these works show high activity and excellent anti-soot-forming properties.

At present, new composite catalysts are prepared not only by traditional methods of impregnation, but also by modern methods of self-propagating high-temperature synthesis (SHS) and combustion in solution [21-25]. Such conditions for the preparation of samples often lead to the synthesis of very active and selective catalysts. In this paper, a comparative study of the catalysts prepared by the above indicated methods in the processes of carbon dioxide conversion and oxidative conversion of methane is presented.

Experimental

Catalyst preparation

The SHS catalysts on the base of Ni-Co-Mg-Ce were prepared from powder mixtures. The specimens were preheated in an electric furnace at 700 – 900°C for several minutes. The second series of catalysts was prepared by the traditional method: samples were prepared by the incipient wetness impregnation of dispersed Al₂O₃ (granule size 100 – 200 μm, S – 57.7 m²/g) by water solutions of metal nitrates with subsequent heating on air at 250°C within 5 h and 600°C within 2 h.

Characterization techniques

The analysis of the initial mixture and reaction products was carried out using a chromatograph "Chromos GC-1000" with the "Chromos" software and on a chromatograph "Agilent Technologies 6890N" (USA) with computer software. Chromatograph "Chromos GC-1000" is equipped with packed and capillary columns. The packed column is used for the analysis of H₂, O₂, N₂, CH₄, C₂H₆, C₂H₄, C₃-C₄ hydrocarbons, CO and CO₂. A capillary column is used to analyze of liquid organic substances, such as alcohols, acids, aldehydes, ketones and aromatic hydrocarbons. The temperature of the detector by thermal conductivity – 200°C, evaporator temperature – 280°C, column temperature – 40°C. Carrier gas velocity Ar = 10 ml/min. The chromatographic peaks were calculated from the calibration curves plotted for the respective products using the "Chromos" software for pure substances. Based on the measured areas of the peaks corresponding to the amount of the introduced substance, a calibration curve $V = f(S)$ was constructed, where V - amount of substance in ml, S - peak area in cm². Concentrations of the obtained products were determined on the basis of the obtained calibration curves. The balance of regulatory substances and products was ± 3.0%.

Catalytic reaction

Experiments on the oxidative conversion were carried out on flow type installation at atmospheric pressure in a tubular quartz reactor with a fixed catalyst bed. The catalyst was placed in the central part of reactor and quartz wool placed above and below the catalyst bed. The free space of the reactor below the catalyst bed was filled with quartz wool to reduce the free volume and gas phase zone of catalyst bed as well as to minimize the further reaction of the desired product in post-catalytic volume. Gas mixture containing methane and carbon dioxide (or oxygen) diluted with an inert gas (Ar) in the presence or absence of water vapor was used for oxidation.

Results and discussion

Dry conversion of methane was studied on the following catalyst 23% Ni + 13% Co + 9% Mg + 5% Ce/36.15% Al + 1.85% Mg, obtained by the SHS method at GHSV = 860 h⁻¹ and a ratio components of the reaction mixture CH₄ : CO₂ : Ar = 33.3 : 33.3 : 33.3 as well as at GHSV = 2500 h⁻¹ at a mixing ratio of CH₄ : CO₂ : Ar = 46.7 : 23.3 : 30.0. The studies were carried out both in the absence and in the presence of water vapor in the reaction mixture. The results are shown in Figure 1.

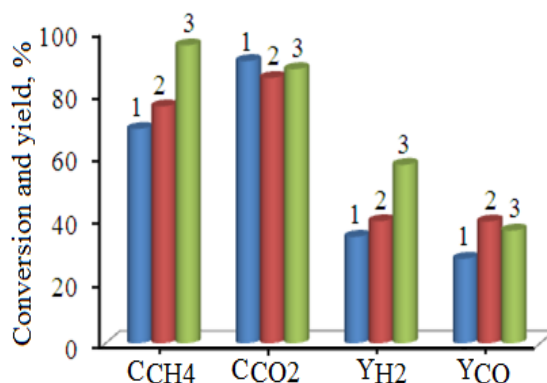

1 – 2500 h⁻¹ in the absence of water vapor, 2 – 860 h⁻¹ in the presence of water vapor, 3 – 860 h⁻¹ in the presence of water vapor.

Figure 1 - Influence of space velocity and the addition of water vapor on feed conversion and yield of reaction products

It can be seen from the figure the space velocity decreases from 2500 h^{-1} to 860 h^{-1} , the conversion of CH_4 , yields of H_2 and CO increase, and the addition of water vapor further increases the conversion of raw materials and the yield of H_2 .

Similar experiments were carried out on the same catalyst composition, however, prepared by impregnation at space velocities of 860 and 2500 h^{-1} at 850 and 900°C in the presence and absence of water vapor. It can be seen from Figure 2 that, in the same way as in the case of SHS catalysts, the addition of water vapor favored the selective yield of H_2 and CO , with higher yields obtained at a space velocity of 860 h^{-1} .

The comparative results shown in Figure 3 indicate that the preparation of the catalyst by the impregnation method is inferior to the SHS method, in which higher values of the feed conversion and H_2 yield are obtained.

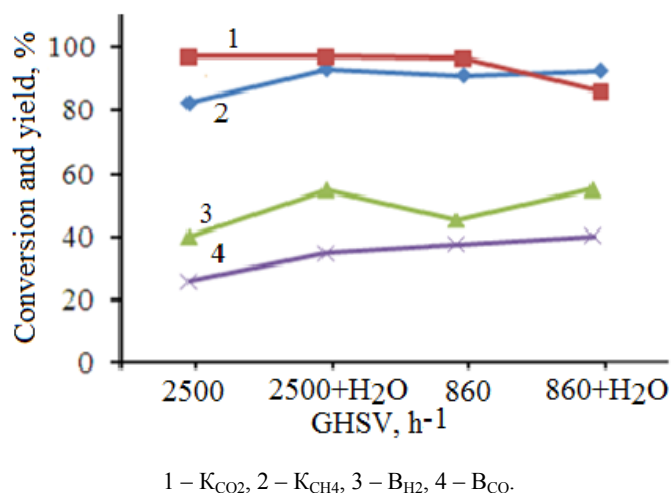

1 - K_{CO_2} , 2 - K_{CH_4} , 3 - B_{H_2} , 4 - B_{CO} .

Figure 2 - Dependence of the conversion of raw materials and the yield of reaction products on the conditions of carrying out the process of carbon dioxide conversion on a catalyst prepared by impregnation

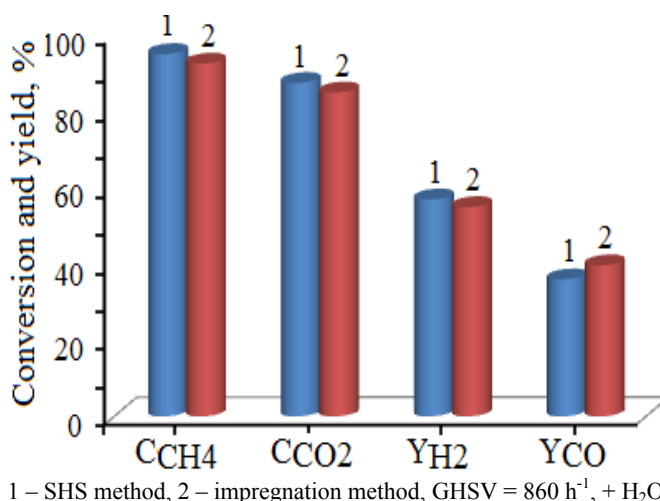

1 - SHS method, 2 - impregnation method, GHSV = 860 h^{-1} , + H_2O .

Figure 3 - Effect of the method of preparation of the catalyst on the parameters of the process of carbon dioxide conversion

Investigation of the activity of catalysts based on the initial mixture of $43\% \text{ Ni}(\text{NO}_3)_2 + 4\% \text{ Co}(\text{NO}_3)_2 + 2\% \text{ Mg}(\text{NO}_3)_2 + 1\% \text{ Ce}(\text{NO}_3)_2 + 50\% \text{ glycine} + 36.15\% \text{ Al}(\text{NO}_3)_3 + 11.85\% \text{ Mg}(\text{NO}_3)_2$ obtained in solution combustion synthesis (SCS) was conducted in the oxidative conversion of methane. A mixture of $34\% \text{ CH}_4$, $17\% \text{ O}_2$ and $50\% (\text{Ar} \pm \text{H}_2\text{O})$, $\text{CH}_4: \text{O}_2 = 2 : 1$ was used to study the oxidation of methane to synthesis gas in the temperature range $700 - 900^\circ\text{C}$. The results on the yield of hydrogen and CO , as well as the selectivity for the target products for these catalysts as a function of temperatures ($700 \pm 900^\circ\text{C}$) are shown in Figures 4a and 4b.

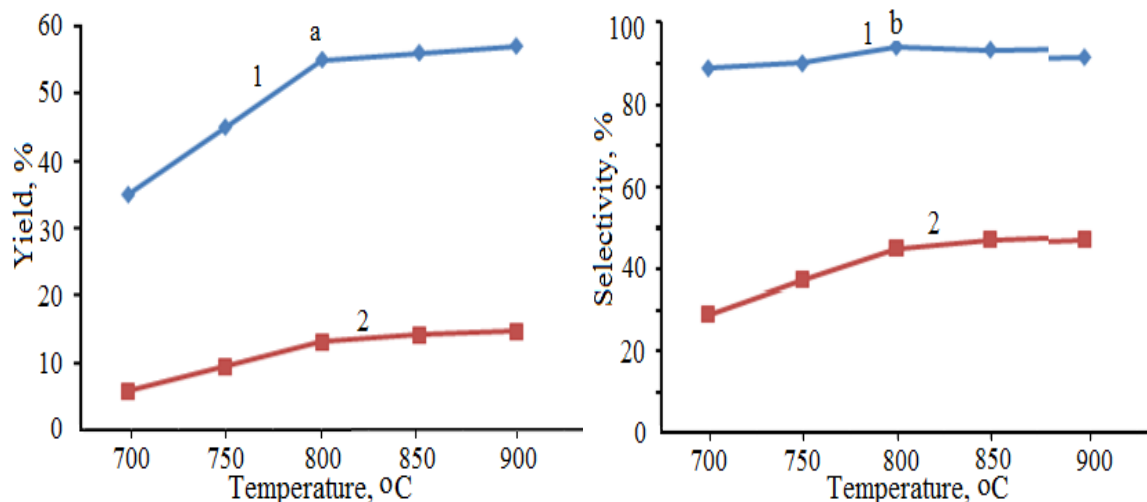

a – yield: 1 - H₂, 2 - CO; b – selectivity: 1 - H₂, 2 - CO; GHSC = 2500 h⁻¹.

Figure 4 - Effect of varying the process temperature on the yield and selectivity for H₂ and CO on the catalyst 43% Ni(NO₃)₂ + 4% Co(NO₃)₂ + 2% Mg(NO₃)₂ + +50% glycine + 36.15% Al(NO₃)₃ + 13.85% Mg(NO₃)₂

As a result of the temperature variation, it was found that carrying out the process at 900°C makes it possible to achieve the highest values of both yield and selectivity for H₂ and CO, but the ratio H₂/CO decreases from 6.1 (T = 700°C) to 3.9 (T = 900°C) at GHSV = 2500 h⁻¹.

On this catalyst, the yields of hydrogen and CO, their selectivity as well as the H₂/CO ratio, which plays an important role in further syntheses of alcohols and hydrocarbons, were determined when the temperature and space velocities varied from 1000 to 8500 h⁻¹. It was shown it is possible to obtain the highest yield and selectivity parameters for the target products at space velocities from 1000 to 2500 h⁻¹. For example, up to 55.8 - 56.9% H₂, 14.6% CO with a selectivity up to 93.6% by hydrogen and 48% by CO, a ratio of H₂/CO = 3.8 - 3.9 were obtained at GHSV = 2500 h⁻¹. Similar results were obtained at a space velocity of 1000 h⁻¹. A further increase in the space velocity leads to a decrease in the process indices, Figures 5a and 5b.

On these catalyst compositions, the addition of water vapor to the initial reaction mixture and variation of CH₄ : H₂O ratio (1 : 0, 1 : 1, 1 : 0,5, 1 : 0,3, 1 : 0,25) were investigated. It has been established that the addition of water vapor to the CH₄ : H₂O = 1 : 0.5 ratio slightly increases the yield of synthesis gas, while increasing the yield of H₂ from 55.8 - 56.9 to 63.0 - 64.0%, and CO - from 14.0 to 15.6 - 15.8%, Figure 6. Further increase in the vapor content to the ratio CH₄ : H₂O = 1 : 1 leads to a decrease in yield and selectivity. The ratio of H₂/CO remains practically unchanged in the range 3.9 - 4.0.

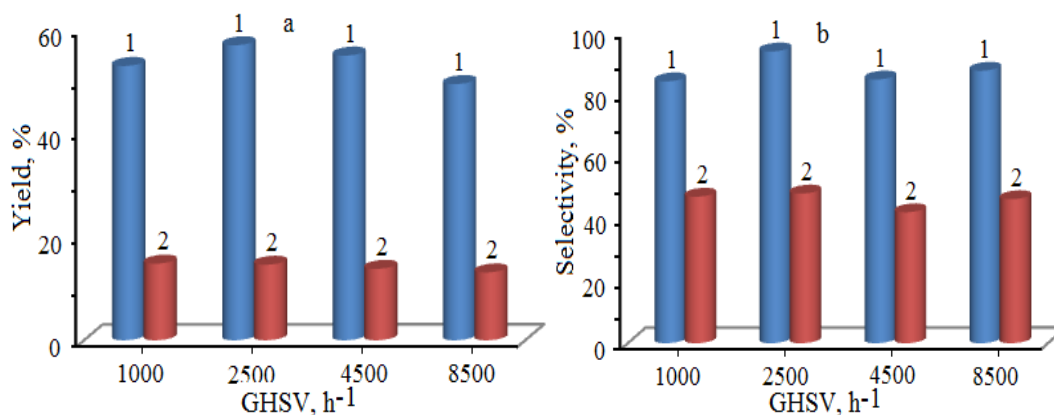

a – yield: 1 - H₂, 2 - CO; b – selectivity: 1 - H₂, 2 - CO; GHSV = 2500 h⁻¹.

Figure 5 - Influence of the variation of the process space velocity on the yield and selectivity for H₂ and CO on the catalyst 43% Ni(NO₃)₂ + 4% Co(NO₃)₂ + 2% Mg(NO₃)₂ + 50% glycine + 36.15% Al(NO₃)₃ + 13.85% Mg(NO₃)₂

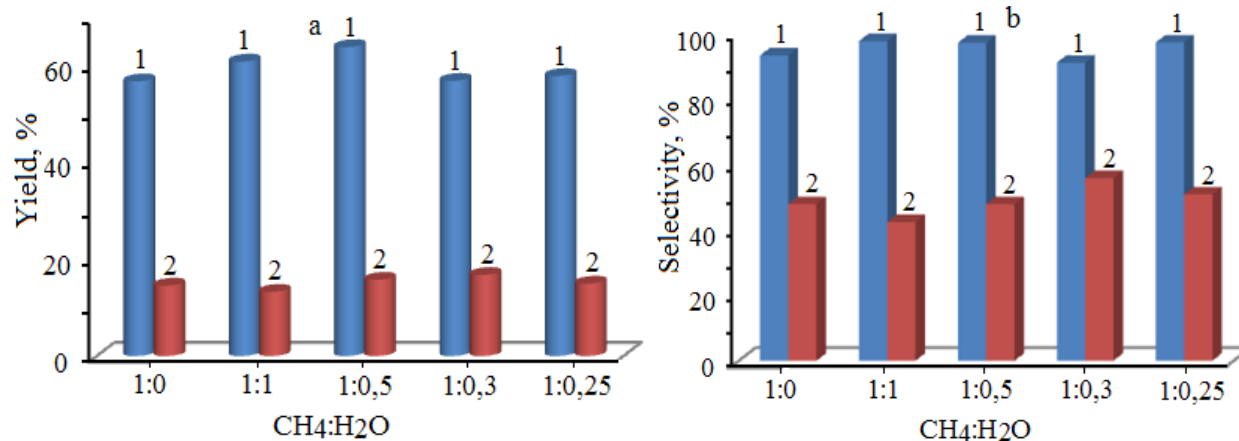

a – yield: 1 - H₂, 2 – CO; b – selectivity: 1 - H₂, 2 - CO; GHSV = 2500 h⁻¹.

Figure 6 - Effect of water vapor content in the reaction mixture on the yield and selectivity of the process for H₂ and CO

Reducing the dilution of the reaction mixture (as a result of decreasing the Ar content) increases the yields for H₂ (from 55.8 to 69.7%) and CO (from 14.0% to 21.0%), but decreases the selectivity for products (H₂ - up to 53.7%, CO - 32.5%) while maintaining the ratio H₂ : CO = 3.3.

Conclusion

23% Ni + 13% Co + 9% Mg + 5% Ce/36.15% Al + 1.85% Mg catalysts prepared by self-propagating high-temperature synthesis and impregnation method were investigated in dry conversion and oxidation of methane at different space velocities, temperatures and compositions of reaction mixture. It was found that the preparation of the catalyst by impregnation method is inferior to the SHS method, in which higher values of the feed conversion and H₂ yield are obtained. As a result of the temperature variation, it was found that carrying out the process at 900°C makes it possible to achieve the highest values of both yield and selectivity for H₂ and CO, but H₂/CO ratio decreases from 6.1 (T = 700°C) to 3.9 (T = 900°C) at GHSV = 2500 h⁻¹. It has been established that the addition of water vapor to the CH₄ : H₂O = 1 : 0.5 ratio slightly increases the yield of synthesis gas, while increasing the yield of H₂ from 55.8 - 56.9 to 63.0 - 64.0%, and CO - from 14.0 to 15.6 - 15.8%.

Acknowledgments

The work was supported by the Ministry of Education and Science of the Republic of Kazakhstan (Grant No AP05132348).

REFERENCES

- [1] Lou Y, Steib M, Zhang Q, Tiefenbacher K, Horváth A, Jentys A, Liu Y, Lercher JA (2017) Design of stable Ni/ZrO₂ catalysts for dry reforming of methane, *J Catal*, 356:147-156. <https://doi.org/10.1016/j.jcat.2017.10.009> (in Eng).
- [2] Zhao B, Yan B, Yao S, Xie Z, Wu Q, Ran R, Weng D, Zhang C, Chen JG (2018) LaFe_{0.9}Ni_{0.1}O₃ perovskite catalyst with enhanced activity and coke-resistance for dry reforming of ethane, *J Catal*, 358:168-178. <https://doi.org/10.1016/j.jcat.2017.12.012> (in Eng).
- [3] Lu Y, Guo D, Ruan Y, Zhao Y, Wang S, Ma X (2018) Facile one-pot synthesis of Ni@HSS as a novel yolk-shell structure catalyst for dry reforming of methane, *J CO₂ Utilization*, 24:190-199. <https://doi.org/10.1016/j.jcou.2018.01.003> (in Eng).
- [4] Egawa C (2018) Methane dry reforming reaction on Ru(001) surfaces, *J Catal*, 358:35-42. <https://doi.org/10.1016/j.jcat.2017.11.010> (in Eng).
- [5] Xin J, Cui H, Cheng Z, Zhou Z (2018) Bimetallic Ni-Co/SBA-15 catalysts prepared by urea co-precipitation for dry reforming of methane, *Appl Catal A*, 554:95-104. <https://doi.org/10.1016/j.apcata.2018.01.033> (in Eng).
- [6] Hassan HE, Kaydouh MN, Geagea H, Zein HE, Jabbour K, Casale S, Zakhem HE, Massiani P (2016) Low temperature dry reforming of methane on rhodium and cobalt based catalysts: Active phase stabilization by confinement in mesoporous SBA-15, *Appl Catal A*, 520:114-121. <https://doi.org/10.1016/j.apcata.2016.04.014> (in Eng).
- [7] San-José-Alonso D, Juan-Juan J, Illán-Gómez MJ, Román-Martínez MC (2009) Ni, Co and bimetallic Ni-Co catalysts for the dry reforming of methane, *Appl Catal A*, 371:54-59. <https://doi.org/10.1016/j.apcata.2009.09.026> (in Eng).
- [8] Lovell EC, Horlyck J, Scott J, Amal R (2017) Flame spray pyrolysis-designed silica/ceria-zirconia supports for the carbon dioxide reforming of methane, *Appl Catal A*, 546:47-57. <https://doi.org/10.1016/j.apcata.2017.08.002> (in Eng).

- [9] Fan MS, Abdullah AZ, Bhatia S (2009) Catalytic technology for carbon dioxide reforming of methane to synthesis gas, *ChemCatChem*, 1:192-208. DOI: 10.1002/cctc.200900025 (in Eng).
- [10] Galanov SI, Sidorova OI (2014) Effect of a precursor on the phase composition and particle size of the active component of Ni-ZrO₂ catalytic systems for the oxidation of methane into syngas, *Russ J Phys Chem A*, 88:1629-1636. DOI: 10.1134/S0036024414100136 (in Eng).
- [11] Li M, van Veen AC (2018) Coupled reforming of methane to syngas (2H₂-CO) over Mg-Al oxide supported Ni catalyst, *Appl Catal A*, 550:176-183. <https://doi.org/10.1016/j.apcata.2017.11.004> (in Eng).
- [12] Sarkar B, Tiwari R, Singha RK (2012) Reforming of methane with CO₂ over Ni nanoparticle supported on mesoporous ZSM-5, *Catal Today*, 198:209-214. <http://dx.doi.org/10.1016/j.cattod.2012.04.029> (in Eng).
- [13] Liu R, Yang M, Huang C, Weng W, Wan H (2013) Partial oxidation of methane to syngas over mesoporous Co-Al₂O₃ catalysts, *Chin J Catal*, 34:146-151. [https://doi.org/10.1016/S1872-2067\(11\)60481-6](https://doi.org/10.1016/S1872-2067(11)60481-6) (in Eng).
- [14] Dedov AG, Loktev AS, Komissarenko DA, Mazo GN, Shlyakhtin OA, Parkhomenko KV, Kiennemann AA, Roger AC, Ishmurzin AV, Moiseev II (2015) Partial oxidation of methane to produce syngas over a neodymium-calcium cobaltate-based catalyst, *Appl Catal A*, 489:140-146. <https://doi.org/10.1016/j.apcata.2014.10.027> (in Eng).
- [15] Singha RK, Shukla A, Yadav A, Konathala LNS, Bal R (2017) Effect of metal-support interaction on activity and stability of Ni-CeO₂ catalyst for partial oxidation of methane, *Appl Catal B*, 202:473-488. <https://doi.org/10.1016/j.apcatb.2016.09.060> (in Eng).
- [16] Pantaleo G, La Parola V, Deganello F, Singha RK, Bal R, Venezia AM (2016) Ni/CeO₂ catalysts for methane partial oxidation: Synthesis driven structural and catalytic effects, *Appl Catal B*, 189:233-241. <https://doi.org/10.1016/j.apcatb.2016.02.064> (in Eng).
- [17] Peymani M, Alavi SM, Rezaei M (2016) Preparation of highly active and stable nanostructured Ni/CeO₂ catalysts for syngas production by partial oxidation of methane, *Int J Hydrogen Energy*, 41:6316-6325. <https://doi.org/10.1016/j.ijhydene.2016.03.033> (in Eng).
- [18] Kerzhentsev MA, Matus EV, Rundau IA, Kuznetsov VV, Ismagilov IZ, Ushakov VA, Yashnik SA, Ismagilov ZR (2017) Development of a Ni-Pd/CeZrO₂/Al₂O₃ catalyst for the effective conversion of methane into hydrogen-containing gas, *Kinet Catal*, 58:601-609. DOI: 10.1134/S002315841705010X (in Eng).
- [19] Walker DM, Pettit SL, Wolan JT, Kuhn JN (2012) Synthesis gas production to desired hydrogen to carbon monoxide ratios by tri-reforming of methane using Ni-MgO-(Ce,Zr)O₂ catalysts, *Appl Catal A*, 445-446:61-68. <http://dx.doi.org/10.1016/j.apcata.2012.08.015> (in Eng).
- [20] Ferreria AP, Zanchet D, Araujo JCS, Liberatori JWC (2009) The effects of CeO₂ on the activity and stability of Pt supported catalysts for methane reforming, as addressed by in situ temperature resolved XAFS and TEM analysis, *J Catal*, 263:335-344. DOI:10.1016/j.jcat.2009.02.026 (in Eng).
- [21] Novikov V, Xanthopoulou G, Knysh Y, Amosov AP (2017) Solution Combustion Synthesis of nanoscale Cu-Cr-O spinels: Mechanism, properties and catalytic activity in CO oxidation, *Ceram Int*, 43:11733-11742. <https://doi.org/10.1016/j.ceramint.2017.06.004> (in Eng).
- [22] Marinou A., Xanthopoulou G, Vekinis G, Lekatou A, Vardavoulias M (2015) Synthesis and heat treatment of sprayed high temperature NiAl-Ni₃Al coatings by in flight combustion synthesis (CAFSY). *Int J Self Propagating High Temperature Synthesis*, 24:192-202. DOI: 10.3103/S106138621504007X (in Eng).
- [23] Varma A, Mukasyan AS, Rogachev AS, Manukyan KhV (2016) Solution combustion synthesis of nanoscale materials, *Chem Rev*, 116:14493-14586. DOI: 10.1021/acs.chemrev.6b00279 (in Eng).
- [24] González-Cortés SL, Imbert FE (2013) Fundamentals, properties and applications of solid catalysts prepared by solution combustion synthesis (SCS), *Appl Catal A*, 452:117-131. <https://doi.org/10.1016/j.apcata.2012.11.024> (in Eng).
- [25] Tungatarova SA, Xanthopoulou G, Karanasios K, Baizhumanova TS, Zhumabek M, Kaumenova G (2017) New composite materials prepared by solution combustion synthesis for catalytic reforming of methane, *Chemical Engineering Transactions*, 61:1921-1926. DOI:10.3303/CET1761318 (in Eng).

ӘОК 542.943; 547.211;661.961;661.993

С.А. Тунгатарова^{1,2}, Г. Ксандопуло³, Т.С. Байжуманова¹, М. Жумабек¹,
Г.Н. Кауменова^{1,2}, Н.А. Амренова², А.К. Салиманова⁴, А. Райысов²

¹Д.В.Сокольский атындағы «Жанармай, катализ және электрохимия институты» АҚ, Алматы, Қазақстан;

²Әл-Фараби атындағы Қазақ ұлттық университеті, Алматы, Қазақстан;

³Нанотехнология және наноғылым институты, «Демокрит» ҰҒЗО, Афины, Греция;

⁴Қ.Жұбанов атындағы Ақтөбе өңірлік мемлекеттік университеті, Ақтөбе, Қазақстан

МЕТАНДЫ СИНТЕЗ-ГАЗҒА Ni-Co-Mg-Ce КАТАЛИЗАТОРЛАРЫ ҚАТЫСЫНДА ҚҰРҒАҚ РЕФОРМИНГЛЕУ МЕН ТОТЫҚТЫРУ КОНВЕРСИЯСЫ

Аннотация. Жаһандық жылынды төмендету жағдайларына байланысты экологиялық мәселелерді шешуде метаннан синтез-газ алу әдісінің оңтайлы үрдісін қолайлы жағдайда жүзеге асыру үшін каталитикалық көмірқышқылды конверсиясы тиімді болып табылады. Ертіндеме жану үрдісі арқылы алынған

Ni-Co-Mg-Ce негізіндегі катализаторлардың белсенділігі метанды тотықтыра айналдыру және көмірқышқылды конверсиясы үрдісінде зерттелді. Салыстырмалы зерттеу нәтижелерінің қорытындысы сіңіру әдісіне қарағанда өздігінен жану әдісімен дайындалған катализаторларда сутектің шығымы және шикізат конверсиясының мәні жоғары екенін көрсетті.

Түйін сөздер: құрғақ реформинг, жоғарытемпературада өздігінен жану синтезі, метан, синтез-газ.

УДК 542.943; 547.211;661.961;661.993

С.А. Тунгатарова^{1,2}, Г. Ксандопуло³, Т.С. Байжуманова¹, М. Жумабек¹,
Г.Н. Кауменова^{1,2}, Н.А. Амренова², А.К. Салиманова⁴, А. Райысов²

¹АО «Институт топлива, катализа и электрохимии им. Д.В. Сокольского», Алматы, Казахстан;

²Казахский национальный университет им. аль-Фараби, Алматы, Казахстан;

³Институт нанонауки и нанотехнологий, ИЦНИ Демокрит, Афины, Греция;

⁴Актюбинский региональный университет им. К. Жубанова, Актобе, Казахстан

СУХОЙ РЕФОРМИНГ И ОКИСЛИТЕЛЬНАЯ КОНВЕРСИЯ МЕТАНА В СИНТЕЗ-ГАЗ В ПРИСУТСТВИИ Ni-Co-Mg-Ce КАТАЛИЗАТОРОВ

Аннотация. Каталитическая углекислотная конверсия метана является предпочтительным способом получения синтез-газа в связи с осуществлением процесса в более мягких условиях и решением экологических проблем, связанных со снижением темпов глобального потепления. Активность катализаторов на основе Ni-Co-Mg-Ce, полученных в процессе горения в растворе, была исследована в процессах углекислотной конверсии и окислительного превращения метана. Сравнительные результаты указывают на то, что приготовление катализатора методом пропитки уступает методу СВС, при котором получены более высокие значения конверсии сырья и выхода H₂.

Ключевые слова: сухой реформинг, самораспространяющийся высокотемпературный синтез, метан, синтез-газ.

Information about authors:

Tungatarova S.A. – Chief Researcher, Doctor of Chemical Sciences, Laboratory of Organic Catalysis, JSC “D.V. Sokolsky Institute of Fuel, Catalysis and Electrochemistry”, Al-Farabi Kazakh National University, Almaty, Kazakhstan. Tel: +77272916632, e-mail: tungatarova58@mail.ru;

G. Xanthopoulou - Professor, PhD, DSc, Laboratory of Modern Ceramics, Institute of Nanoscience and Nanotechnology, NCSR “Demokritos”, Athens, Greece. g.xanthopoulou@inn.demokritos.gr;

T.S. Baizhumanova - Leading Researcher, Candidate of Chemical Sciences, Laboratory of Organic Catalysis, JSC “D.V. Sokolsky Institute of Fuel, Catalysis and Electrochemistry”, Almaty, Kazakhstan. Tel: +77272916632, e-mail: baizhuma@mail.ru;

M. Zhumabek - Junior Researcher, Laboratory of Organic Catalysis, JSC “D.V. Sokolsky Institute of Fuel, Catalysis and Electrochemistry”, Almaty, Kazakhstan. Tel: +77272916632, e-mail: manapkhan_86@mail.ru;

G.N. Kaumenova - PhD Doctoral Student, Al-Farabi Kazakh National University, Laboratory of Organic Catalysis, JSC “D.V. Sokolsky Institute of Fuel, Catalysis and Electrochemistry”, Almaty, Kazakhstan. kaumenova.gulnar@mail.ru;

N.A. Amrenova - Graduate Student, Al-Farabi Kazakh National University, Almaty, Kazakhstan. nazik-14@mail.ru;

A.K. Salimanova - Graduate Student, K. Zhubanov Aktobe Regional State University, Aktobe, Kazakhstan. aiguls84@mail.ru;

A. Raiyssov - Graduate Student, Al-Farabi Kazakh National University, Almaty, Kazakhstan. araiyssov2014@gmail.com

NEWS

OF THE NATIONAL ACADEMY OF SCIENCES OF THE REPUBLIC OF KAZAKHSTAN

SERIES CHEMISTRY AND TECHNOLOGY

ISSN 2224-5286

Volume 3, Number 429 (2018), 20 – 27

UDC 547-386

B. Łęska¹, A. Tukibayeva², N. Kalieva³

¹Adam Mickiewicz University in Poznan, Poland;

²M. Auezov South Kazakhstan state university, Shymkent, Kazakhstan;

³Kh.A.Yassawi Kazakh-Turkish International University, Kazakhstan

e-mail: ainur_tukibaeva@mail.ru

STRUCTURE AND ELECTROCHEMICAL REACTIVITY OF Si-ORGANIC COMPOUNDS MONOLAYERS ADSORBED ON SILVER SURFACE

Abstract. In this paper, the results of the research on the structure and electrochemical reactivity of silicon-organic compounds monolayers adsorbed on the silver surface are given. The compact siloxane films, bringing about an inhibiting effect on the electroreduction of propylene carbonate as well as Li deposition on the Ag electrode, have been obtained with 3-[Tris(2-methoxyethoxy)silyl]-propanethiol (SiCC). We also obtained 4,7-diazaheptyl-trimethoxy-silane (SiNN) and vinyl-trialkoxysilane (SiDD), which could be also interesting in view of corrosion prevention. The results of a study on the behaviour of these compounds on the silver surface are presented. The structures of SiCC, SiNN and SiDD and these complexes with cations on the Ag surface were calculated and visualized by the AM1d semi-empirical method. The structures of the SiCC, SiNN and SiDD molecules and their complexes in solution and after the adsorption process on silver are discussed. Some of the semi-empirical calculated HOF (heat of formation) values for uncomplexed and complexed species and the differences between them (Δ HOF) are calculated by the PM5 method. These values indicate the formation of 1:1 complexes of SiDD with Li^+ cation and 1:7–8 of SiNN with Li^+ cations. The respective calculations of Δ HOF on the assumption that these molecules are bonded by the coordinative interactions between the Ag surface and the electron lone pair at the N atom of SiDD or the π electrons of the vinyl group of SiNN resulted in the negative Δ HOF values and demonstrated that this kind of interaction is very probable. The calculated distances between the Ag atoms from the surface and the respective coordinating N atom or vinyl group in SiDD and SiNN molecules are 2.35 and 2.50 Å, respectively. Silver immersion into SiCC, SiNN and SiDD solutions in PC leads to the formation of well-ordered and electrochemically inactive self-assembled monolayers. The AM1d calculations suggest that the SiCC, SiNN and SiDD molecules are physically adsorbed with the silver surface atoms.

Keywords: Self-assembled monolayers, silicon-organic compounds, electrochemical activity, silver electrode surface, adsorption.

Introduction

Organosilicon chemistry is based on the fact that although the energy of Si-O and Si-C bonds is similar to that of their purely organic counterparts, these bonds are longer and more polarized, which makes them more flexible in terms of physical and chemical properties [1-3].

The steric hindrance and, therefore, barrier for rotation is far lower in a siloxane backbone than in a carbon chain, which implies higher gas permeability, lower melting points and glass transition temperatures along with a wider range of solubility observed for siloxanes [4]. At the same time, the electronegativity of silicon atom (1.90, Pauling) is sufficiently low for the siloxane bridge to be cleaved in alkaline and highly acidic conditions [5]. Condensation of resulting silanol moieties, Si-OH, is the basis for obtaining a whole class of siliceous materials, from cost-effective amorphous silica gels, to specifically tailored silica nanoparticles (e.g. Stober silica) [6], to periodic mesoporous organosilicas (PMOs) [7]. All of those can be easily further functionalized. Taking advantage of the aforementioned reactivity of the polarized Si-O bond, one can graft specific organic moieties on the surface of a resilient, non-toxic and well-defined matrix, very often with a large surface area [8].

Silica-based materials are commonly used in the laboratory and frequently synthesized for purposes like separation [9], extraction [10], controlled drug release [11], templating [12], sensing [13], powder-type emulsions stabilization [14], heterogeneous catalysis [15] and many others. Siloxanes, however, are mainly encountered in polymer science, and the usefulness of smaller compounds comprising siloxane bridges remains fairly unexplored, with few notable exceptions in supramolecular chemistry of metal complexes [16-18].

Considerable attention has been drawn during the last few decades to modify noble metal surfaces by forming ordered organic films of few nanometers to several hundred nanometers thickness [19–22]. One of the simplest means of forming these ultrathin films is by the mere immersion of the noble metal surface in a dilute solution (mM) of the organic molecule at ambient conditions and this unimolecular organic film is popularly known as self-assembled monolayers (SAM). Indeed, SAM formation provides one easy route towards surface functionalisation by organic molecules (both aliphatic and aromatic) containing suitable functional groups like –SH, –CN, –COOH, –NH₂ and silanes on selected metallic (Au, Cu, Ag, Pd, Pt, Hg and C) as well as semiconducting surfaces (Si, GaAs, indium coated tin oxide etc.) [23]. These type of SAM modified surfaces are highly useful for investigating several fundamental phenomena such as distance dependent electron transfer [24], mechanism of single electron transfer [25], observation of molecular event such as Coulomb staircase [26] etc. on artificially designed nanostructures.

Due to the highly ordered nature and tight packing, these monolayers on metallic surfaces are also important for several practical applications such as chemical sensing, control of surface properties like wettability and friction corrosion protection, patterning, semi-conductor passivation, and optical second harmonic generation [19].

Molecular engineering is an interdisciplinary area where supramolecular systems are designed capable of electronic operations like switching, gating, rectification, amplification etc. The primary objective is to design and synthesize suitable building blocks with novel and potentially useful electronic properties. Aside from organizing interesting molecules in two dimensions, development of nanotechnology also needs suitable size functional building blocks to continue the fabrication of nanoarchitectures. Colloidal particles or clusters of metal and semiconductors are immensely suitable as building blocks to tailor these types of nanodevices due to their unique optical [27] and electronic properties [28]. Flexibility in functionalizing the terminal groups of SAM-modified surfaces allows the build-up of nanoarchitectures with these nanoparticles. If a single molecule can serve as a switch or a logic device its size allows the utilization of about 10^{13} units/cm² compared to the presently used level of 10^8 units/cm². For memory applications, “one bit per molecule” can give unprecedented storage density along with the other attendant advantages of size reduction. SAM is a simple way to organize 10^{13} molecules/cm² and hence is immensely suitable for achieving these objectives [29]. In addition, improved response time and low power, as observed in systems of biological electron transfer, are other benefits.

The word SAM generally denotes a monomolecular thick film of organic compounds on flat (i.e., two-dimensional) metal or semiconductor surfaces. SAM formation provides one of the easiest ways to obtain ordered monolayers through strong chemisorptions between the substrate head group of a desired compound and the metal surface leading to the preparation of thermodynamically stable monolayers [20-22] as compared to LB (Langmuir–Blodgett) and other techniques, where only physisorbed, thermally unstable mono/multilayer films are obtained. Several studies show that long-chain alkane thiols (containing more than six to seven methylene units) form more well-ordered defect-free monolayers than short-chain alkane thiols, disulphides or sulphides. Aromatic (π systems like benzene, naphthalene or diphenylene systems) or/and hydrogen-bonded molecules with multiple contacts, containing functional groups like thiols, amines, sulphides, selenides etc. provide improved stability [19].

One of the important advantages of SAM is that they can be prepared in the laboratory by simply dipping the desired substrate in the required millimolar solution for a specified time followed by thorough washing with the same solvent and drying, often using a jet of dry argon. Gas-phase evaporation of the adsorbant can also form good monolayers, although structural control is difficult. Several factors affect the formation and packing density of monolayers, like nature and roughness of substrate, solvent used, nature of the adsorbate, temperature, concentration of adsorbate etc. Cleanliness and crystallinity of the substrate also play a crucial role in determining the compactness, often quantitatively estimated by the pinhole distribution.

Electrochemical techniques like cyclic voltammetry (CV) [30], and impedancemeasurements [31, 32] are easy techniques for monitoring monolayer characteristics. These electrochemical studies also provide useful information about the distribution of defects like pinholes, redox property of attached groups (ferrocene, ruthenium bipyridine, and simple bipyridine molecules), kinetics and mechanism of monolayer formation, quantitative estimate of coverage etc.

In this article, we describe the results of a study on the behaviour of compounds of SiCC, SiNN and SiDD and these complexes with lithium cations in solution and after the adsorption process on the silver surface.

Methods

SiCC was synthesized by trans-esterification reaction in benzene of 3-(trimethoxysilyl)-propanethiol with ethanol or ethylene glycol monomethylether and traces of dibuthyltin oxide as a catalyst in benzene as solvent.

The obtained product was purified by vacuum distillation. The purity of the product was controlled by ^1H NMR spectroscopy. 3-(trimethoxysilyl)-propanethiol was used as commercial product (Aldrich) after vacuum distillation. The 4,7-diazaheptyl-trimethoxy-silane (SiNN) and vinyl-trialkoxo-silane (SiDD) were commercial products of ABCR Gelest and were used without any purifications. The purity of the products were controlled by ^1H NMR spectroscopy.

The electrolyte solutions for electrochemical measurements were made using propylene carbonate (PC) from Merck purified by fractional distillation in dry argon atmosphere and dried over 4 Å molecular lithium sieves. LiClO_4 (Aldrich) was dried in a vacuum oven below its melting point.

Adsorption procedure

Silver strips (99.999%) were polished with aluminium slurries (Buehler) of successively decreasing final grades (down to 0.05 μm) on polishing cloths (Buehler), rinsed carefully with a dry solvent (acetonitrile or propylene carbonate). The 3-(trimethoxysilyl)-propanethiol, SiCC, SiNN and SiDD adsorbates were formed on the silver strips both from the liquid thiol compounds and from their acetonitrile or propylene carbonate (PC) solutions (0.2 M). After taking out from the liquid phase, the adsorbates were rinsed with a pure and dried solvent (acetonitrile or propylene carbonate) and allowed to dry 12 h in the water free argon atmosphere. Furthermore, the surface layer was subsequently subjected to hydrolysis and condensation by immersing the SiCC modified sample in water for 12 h.

FT-IR spectroscopy

The reflection-absorption spectra for 3-(trimethoxysilyl)-propanethiol, SiCC, SiNN and SiDD adsorbates on smooth silver strips were obtained in an N_2 atmosphere on a Bruker 113 V FT-IR spectrometer with an FT-80 grazing angle infrared reflection accessory and a liquid N_2 cooled TGS detector. Typically, 2000 scans with 1 cm^{-1} resolution were performed. Additionally, for comparison, the transmission FT-IR spectra of the thiol substrates were recorded on the same spectrometer.

Results and discussion

The formulae of these molecules are given in Fig 1. [33].

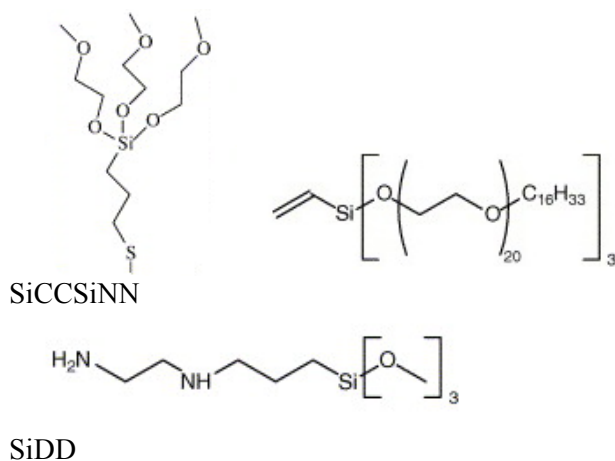

Figure 1 - The formulae of 3-[Tris(2-methoxyethoxy)silyl]-propanethiol (SiCC), 4,7-diazaheptyl-trimethoxy-silane (SiNN) and vinyl-trialkoxo-silane (SiDD)

AM1d and PM5 semi-empirical calculations. Semi-empirical AM1d and PM5 calculations of the structures of non-adsorbed and adsorbed SiCC, SiNN and SiDD molecules as well as their complexes with Li^+ cations and maximum surface packing density were made using the WinMopac program (Figs. 2-5).

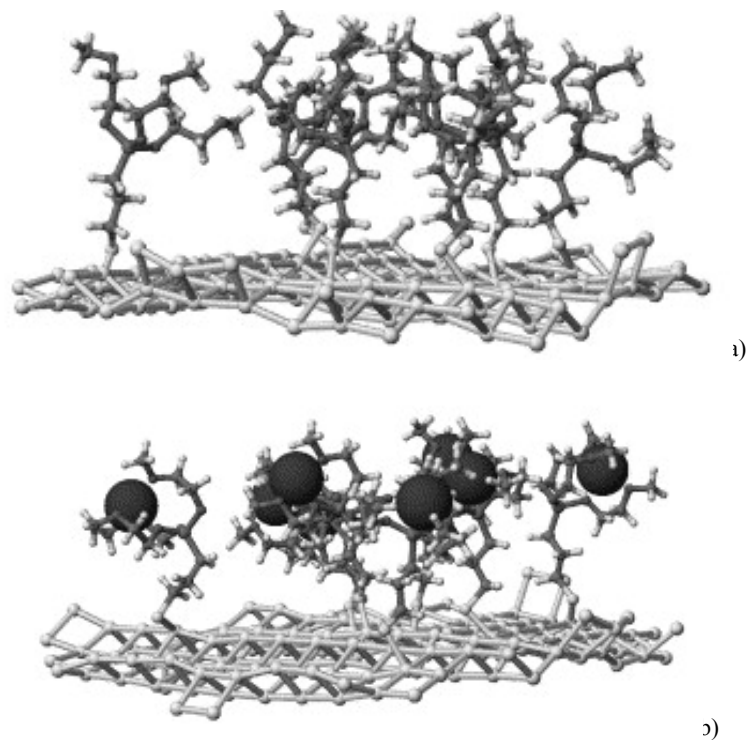

Figure 2 - The structure of the surface layer with 60% of maximum packing density of SiCC molecules on Ag; (a) without Li^+ cations and (b) with Li^+ cations.

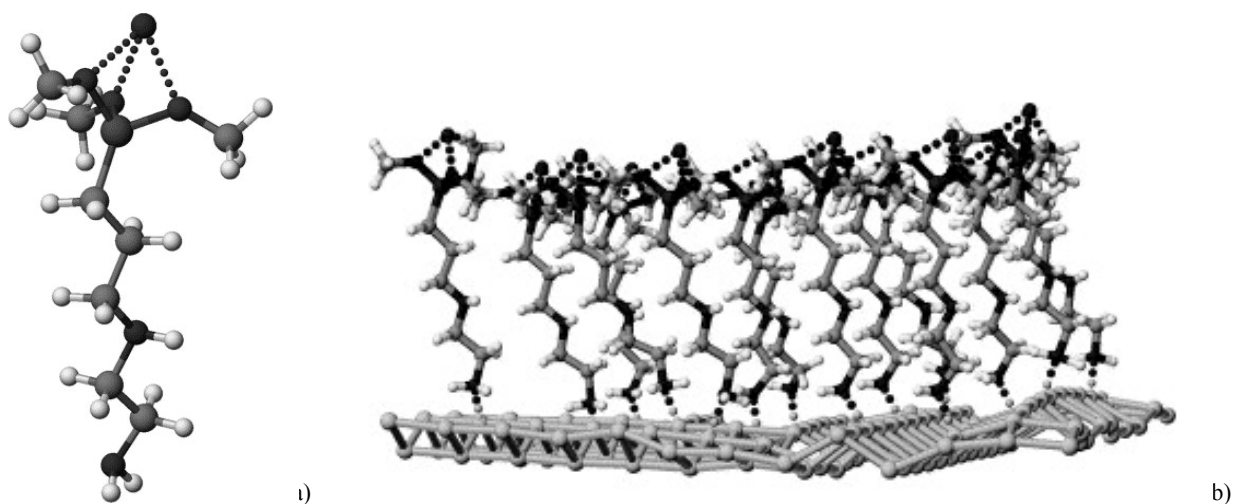

Figure 3 - a) The structure of the complex of SiNN with Li^+ cation; b) The structure of the surface layer of SiNN complexed with Li^+ on Ag with 68.6% of maximum packing

Some of semi-empirical calculated HOF (heat of formation) values for uncomplexed and complexed species and the differences between them (ΔHOF) are calculated by PM5 method. These values indicate the formation of 1:1 complexes of SiDD with Li^+ cation and 1:7–8 of SiNN with Li^+ cations. The results obtained for the SiNN molecule are well comparable with the experimental ΔH data as well as the number of complexed Li^+ cations reported previously [34-35].

The visualization of the representative favourable structures of 1:1 and 1:7 respective complexes are shown in Figs. 3a and 4. The Li^+ cation in the structure of the 1:1 complex of SiDD is coordinated by the oxygen atoms of the methoxy groups. In the structure of SiNN complexes the first Li^+ cation is coordinated by the oxygen atoms neighboring the silicon atom and every other cation is localized at a maximal distance from the others. This is visualized in the structure of 1:7 complex of SiNN with Li^+ cations given in Fig. 4.

The respective calculations ΔHOF on the assumption that these molecules are bonded by the coordinative interactions between the Ag surface and the electron lone pair at ω N atom of SiDD or the π electrons of the vinyl group of SiNN resulted in the negative ΔHOF values and demonstrating that this kind of interactions is very probable. The calculated distances between the Ag atoms from the surface and the respective coordinating N atom or vinyl group in SiDD and SiNN molecules are 2.35 and 2.50 Å, respectively.

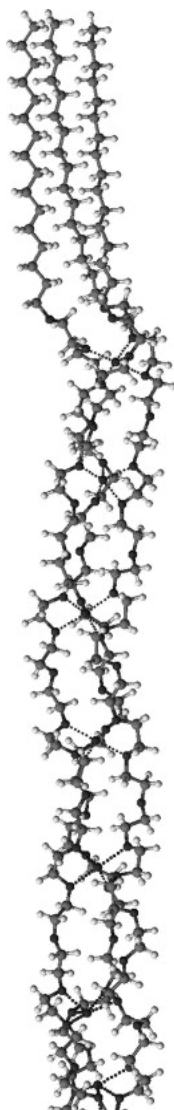

Figure4 - The structure of the 1:7 complex of SiDD with Li^+ cations.

On the basis of the AM1d calculations, the area per one adsorbed molecule in a densely packed layer of SiDD and SiNN with the long oxaalkyl chains in an almost perpendicular orientation with respect to the electrode surface was found to be 0.268 and 0.40 nm², respectively. The surface concentration of 3.73×10^{14} molecules per cm² for SiDD and 2.50×10^{14} molecules per cm² for SiNN at a saturation coverage of the silver surface.

Further calculations were performed for surfaces with about 60% of the maximum packing density. On such assumption, the distribution of SiDD or SiNN molecules on the Ag surface has more or less statistical character. The molecules adsorbed are able to form complexes with Li^+ cations comparable to those discussed above for free molecules. The respective structures of the monolayers on the silver surfaces of non-complexed SiNN molecules and of complexed with Li^+ cations SiDD molecules are shown in Figs. 3 b and 5.

The other calculations were performed for surfaces with 60% of maximum packing density. On this assumption, the distribution of SiCC molecules on the Ag surface has more or less statistical character (Fig. 2a), but the Fig. 2b shows the structure of the same model after complexation of Li^+ cations. The calculations suggest that Li^+ cations are bonded in a favorable way within each molecule between the oxaalkyl chains.

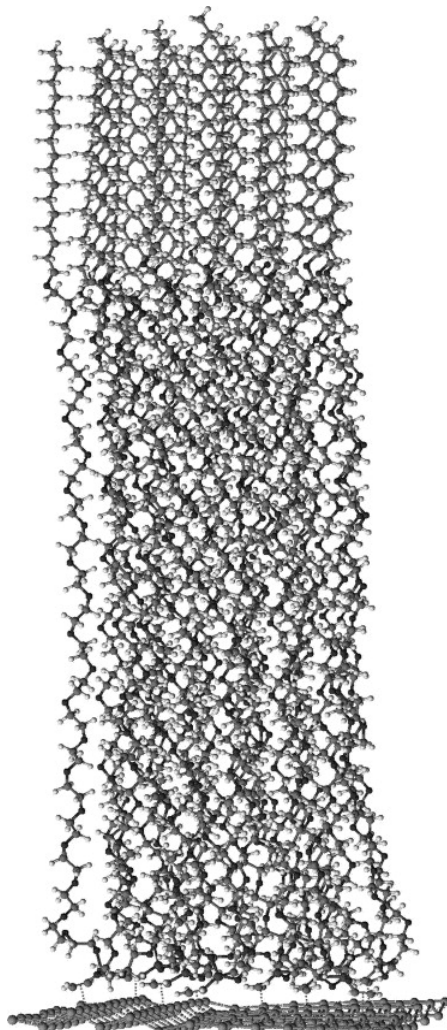

Figure 5 - The structure of the surface layer of SiDD on Ag with 58.0% of maximum packing density.

Conclusions

Silver immersion into SiCC, SiNN and SiDD solutions in PC leads to formation of well-ordered and electrochemically inactive self-assembled monolayers. The AM1d calculations suggest that the SiCC, SiNN and SiDD molecules are physically adsorbed with the silver surface atoms. The SiCC, SiNN and SiDD species alone and after adsorption on the Ag surface form complexes with Li^+ cations, coordinated by oxygen atoms of the oxaalkyl chains.

Acknowledgements

Authors thanks the Committee of Science of the Ministry of Education and Science of the Republic of Kazakhstan for financial support under Grant No 203-32 from 03.03.2017.

REFERENCES

- [1] Colvin E.W. *ChemSoc Rev.* **1978**, 7, 15–64 (in Eng.)
[2] Weinhold F., West R., *J. Am. Chem. Soc.*, **2013**, 135(15), 5762–5767 (in Eng.)
[3] Patai S, Rappoport Z, editors. The chemistry of organic silicon compounds. Volume 3 Chichester: John Wiley & Sons, Ltd; **2001** (in Eng.)
[4] Rościszewski P., Zielecka M., *Silikony. Właściwości i zastosowanie [Siloxanes. Properties and application]*. Warsaw: Wydawnictwo Naukowo-Techniczne; **2004**. Polish. (in Pol.)
[5] Cypryk M., Apeloig Y., *Organometallics*. **2002**, 21(11), 2165–2175 (in Eng.)
[6] Ibrahim I.A.M., Zikry A.A.F., Sharaf M.A., *J Am Sci.*, **2010**, 6(11), 985–989 (in Eng.)
[7] Van Der Voort P, Esquivel D., De Canck E., Goethals F., Van Driesscheb I., Romero-Salguero F.J., *ChemSoc Rev.*, **2013**, 42, 3913–3955 (in Eng.)
[8] Jal P.K., Patel S., Mishra B.K., *Talanta*. **2004**, 62, 1005–1028 (in Eng.)
[9] Pu Q, Sun Q., *Analyst*. **1998**, 123, 239–243 (in Eng.)
[10] Wang N., Liang X, Li Q., Liao Y., Shao S., *RSC Adv*, **2015**, 5, 15500–15506 (in Eng.)
[11] Kittappa S., Cui M., Ramalingam M., Ibrahim S., Khim J., Yoon Y., et al. *PLoS ONE*, **2015**, 10(7), e0130253 (in Eng.)
[12] Yongbeom S., Kyoungsoo K., Younjae J., Ryong R., *Microporous Mesoporous Mater.* **2015**, 207, 156–162 (in Eng.)
[13] Kubota L.T., Gouvea F., Andrade A.N., Milagres B.G., Neto G.D.O., *Electrochim Acta*, **1996**; 41(9), 1465–1469 (in Eng.)
[14] Ikem V.O., Menner A., Bismarck A., *Angew Chem Int Ed.*, **2008**, 47(43), 8277–8279 (in Eng.)
[15] Shu X.Z., Nguyen S.C., He Y., Oba F., Zhang Q., Canlas C., et al., *J. Am. Chem. Soc.* **2015**, 137(22), 7083–7086 (in Eng.)
[16] Mirela-Fernanda Z., Alexandru M., Cazacu M., Shova S., Novitchi G., Train C., et al. *Eur. J. Inorg. Chem.*, **2014**, 29, 4946–4956. (in Eng.)
[17] Vlad A., Turta C., Cazacu M., Rusu E., Shova S., *Eur. J. Inorg. Chem.*, **2012**, 31, 5078–5084 (in Eng.)
[18] Tabisz Ł., Tukibayeva A., Pankiewicz R., Dobielska M., Leska B., *PLoS ONE*, **2015**, 10(12), e0145680. doi:10.1371/journal.pone.0145680 (in Eng.)
[19] Nirmalya K Chaki, Aslam M., Sharma Jadaband Vijayamohan K. *Proc. Indian Acad. Sci. (Chem. Sci.)*, **2001**, 113, 659–670. (in Eng.)
[20] Ulman A. *An introduction to ultrathin organic films: From Langmuir–Blodgett to self-assembly*, New York: Academic Press, **1991**, 442 (in Eng.)
[21] Dubois L. H. and Nuzzo R.G. *Annu. Rev. Phys. Chem.* **1991**, 43, 437 (in Eng.)
[22] Nuzzo R. G. and Allara D. L., *J. Am. Chem. Soc.*, **1986**, 108, 4481 (in Eng.)
[23] Ulman A. *Chem. Rev.* **1996**, 96, 1533 (in Eng.)
[24] Becka A. M. and Miller C. A. *J. Phys. Chem.*, **1993**, 97, 6233 (in Eng.)
[25] Feldheim D. L. and Keating D. C. *Chem. Soc. Rev.* **1998**, 27, 1 (in Eng.)
[26] Dorogi M., Gomez J., Osifchin R., Andress R. P. and Reinfenberger R., *Phys. Rev.*, **1995**, 52, 9071 (in Eng.)
[27] Alivisatos A. P., *J. Phys. Chem.*, **1996**, 100, 13226 (in Eng.)
[28] Lewis L. N. *Chem. Rev.* **1993**, 93, 2693 (in Eng.)
[29] Brige R. R. (ed.) *Molecular and biomolecular electronics*, Washington DC: Am. Chem. Soc., **1991** (in Eng.)
[30] Bandyopadhyay K., Sastry M., Paul V. and Vijayamohan K., *Langmuir*, **1997**, 13, 866 (in Eng.)
[31] Bandyopadhyay K. and Vijayamohan K., *Langmuir*, **1998**, 14, 625 (in Eng.)
[32] Finklea H. O., Snider D. A., Fedyk J., Sabatani E., Gafni Y. and Rubenstein I., *Langmuir*, **1993**, 9, 3660 (in Eng.)
[33] Tukibayeva A. Report about scientific-research work on the theme: “Development of the obtaining technology of the novel type of anionic receptors as components of hybrid materials tailored for removal of ions detrimental to the natural environment”, Shymkent, **2017**, 47 (in Eng.)
[34] Łeska B., et al., *J. Mol. Struct.*, **2005**, 741, 1–3, 11 (in Eng.)
[35] Luczak T., Pankiewicz R., Leska B., et al., *J. Mol. Struct.*, **2006**, 800, 140 (in Eng.)

Б. Леска¹, А. Тукибаева², Н. Калиева³

¹Познаньдағы Адама Мицкевич Университеті, Польша;

²М.Ауезов атындағы Оңтүстік Қазақстан Мемлекеттік университеті, Шымкент;

³Қ.А.Яссауи атындағы Халықаралық қазақ-түрік университеті, Түркістан

КҮМІСТІҢ БЕТІНДЕ АДСОРБЦИЯЛАНҒАН СИ-ОРГАНИКАЛЫҚ ҚОСЫЛЫСТАР
МОНОҚАБАТТАРЫНЫҢ ҚҰРЫЛЫМЫ ЖӘНЕ ЭЛЕКТРОХИМИЯЛЫҚ
РЕАКЦИЯЛЫҚ ҚАБІЛЕТТЕРІ

Аннотация. Ұсынылып отырған жұмыста күмістің бетінде адсорбцияланған Si-органикалық қосылыстар моноқабаттарының құрылымы және электрохимиялық реакциялық қабілеттерін зерттеу нәтижелері келтірілген. Пропиленкарбонаттың тотықсыздануына, сондай-ақ, күміс электродының бетіне литийдің тұнуына ингибирулеуші әсер ететін компакттылы силосанды жабындар 3- [Трис (2-метоксиэтоксид) силил]-пропантиол (SICC) көмегімен алынды. Сондай-ақ, қазіргі таңда коррозияны алдын алу бойынша қызығушылық туғызатын 4,7-диазагептил-

триметоксисилан (SiNN) және винилтрикоксисилан (SiDD) алынды. Жұмыста осы қосылыстардың күміс бетіндегі электрохимиялық қасиеттері зерттеу нәтижелері келтірілген. SiCC, SiNN және SiDD құрылымдары және күміс бетіндегі катиондармен комплекстері жартылай эмпирикалық тәсілмен AM1d есептелді және нақтыланды. SiCC, SiNN және SiDD және олардың комплекстері молекулаларының ерітіндідегі және Ag бетінде адсорбцияланған кейінгі құрылымдары талқыланды.

Комплекстелмеген және комплекстелген түрлері және олардың арасындағы айырымы (ΔHOF) үшін жартылай эмпирикалық есептелген HOF (түзілу жылулары) шамаларының кейбірі PM5 тәсілімен есептелді. Бұл мәндер 1: 1 Li^+ катионымен SiDD және 1: 7-8 Li^+ катиондарымен SiNN комплекстерінің түзілетіндігін көрсетеді. ΔHOF сәйкес есептеулері көрсеткендей, осы молекулалар беткі қабаттағы күміс пен SiDD-дағы ωN атомындағы электрон жұбының арасындағы координациялық байланыспен немесе SiNN-дағы винилді топтың электрондарымен байланысқан, ΔHOF теріс мәндеріне әкелді және осы әрекеттесудің өте ықтимал екендігін көрсетті. Беттік қабаттағы күміс атомы мен сәйкес келетін N атомы немесе SiDD және SiNN молекулаларындағы винилді топтың арасындағы есептелген ара қашықтық сәйкесінше 2,35 және 2,50 Å құрайды. Пропиленкарбонаттағы SiCC, SiNN және SiDD ерітінділеріне күмісті батыру, жақсы реттелген және электрохимиялық активті емес өздігінен ұйымдасатын моноқабаттарды түзілуіне әкеледі. AM1d есептеу-лері, SiCC, SiNN және SiDD молекулалары беттік қабаттағы күміс атомдарымен физикалық адсорбция-ланады.

Түйін сөздер: өздігінен жинақталатын моноқабаттар, кремнийорганикалық қосылыстар, электрохимия-лық белсенділік, күміс электродының беттік қабаты, адсорбция

Б. Леска¹, А. Тукибаева², Н. Калиева³

¹ Университет Адама Мицкевича в Познани, Польша;

² Южно-Казахстанский государственный университет им. М. Аuezова, Шымкент;

³ Казахско-турецкий международный университет им. Х. а. Ясави, Туркестан

СТРУКТУРА И ЭЛЕКТРОХИМИЧЕСКАЯ РЕАКЦИОННАЯ СПОСОБНОСТЬ МОНОСЛОЕВ SI-ОРГАНИЧЕСКИХ СОЕДИНЕНИЙ, АДсорБИРОВАННЫХ НА ПОВЕРХНОСТИ СЕРЕБРА

Аннотация. В данной статье даны результаты по исследованию структуры и электрохимической реакционной способности монослоев кремнийорганических соединений, адсорбированных на поверхности серебра. Компактные силиконовые пленки, вызывающие ингибирующее воздействие на электровосстановление пропиленкарбоната, а также осаждение Li на серебряном электроде, были получены с 3- [Трис (2-метоксизтокси) силлил] пропантиолом (SiCC). Нами также получены 4,7-диазагептил-триметоксисилан (SiNN) и винилтрикоксисилан (SiDD), которые могут быть интересны с точки зрения предотвращения коррозии. В работе представлены результаты исследования электрохимического поведения этих соединений на поверхности серебра. Были рассчитаны и визуализированы структуры SiCC, SiNN и SiDD и их комплексы с катионами на поверхности серебра полуэмпирическим методом AM1d. Обсуждены структуры молекул SiCC, SiNN и SiDD и их комплексов в растворе и после процесса адсорбции на Ag. Некоторые из полуэмпирических вычисленных величин HOF (теплоты образования) для некомплексных и комплексных видов и различий между ними (ΔHOF) рассчитаны PM5 методом. Эти значения показывают образования 1: 1 комплексов SiDD с катионом Li^+ и 1: 7-8 SiNN с катионами Li^+ . Соответствующие расчеты ΔHOF в предположении, что эти молекулы связаны посредством координационных взаимодействий между поверхностью Ag и электронно-одиночной парой на атоме ωN SiDD или π -электронами виниловой группы SiNN, привели к отрицательным значениям ΔHOF и показали, что этот вид взаимодействия весьма вероятен. Рассчитанные расстояния между атомами Ag с поверхности и соответствующей координирующей N атомом или винильной группой в SiDD и SiNN молекулах составляют 2,35 и 2,50 Å, соответственно. Погружение серебра в растворы SiCC, SiNN и SiDD в пропиленкарбонате приводит к образованию хорошо упорядоченных и электрохимически неактивных самоорганизующихся монослоев. Расчеты AM1d показывают, что молекулы SiCC, SiNN и SiDD физически адсорбируются атомами серебра поверхности.

Ключевые слова: самоорганизующиеся монослои, кремнийорганические соединения, электрохимическая активность, поверхность серебряного электрода, адсорбция

Information about authors:

Łeska Bogusława – Dc.Sc., professor of department of Chemistry, Adam Mickiewicz University in Poznan (Poland), e-mail: bogunial@amu.edu.pl;

Tukibayeva Ainur – candidate of Chemistry, associate professor, department of Chemistry, M. Auezov South Kazakhstan State University, e-mail: ainur_tukibaeva@mail.ru;

Kaliev Nurzia – master of Sc., senior teacher of the Department of Preventative medicine, Kh. A. Yassawi Kazakh-Turkish University, e-mail: nur_2773@mail.ru.

NEWS

OF THE NATIONAL ACADEMY OF SCIENCES OF THE REPUBLIC OF KAZAKHSTAN

SERIES CHEMISTRY AND TECHNOLOGY

ISSN 2224-5286

Volume 3, Number 429 (2018), 28 – 38

UDC 543.621, MRNTI 31.19.15

I. Yu. Silachyov

Institute of Nuclear Physics, Almaty, Kazakhstan

E-mail: silachyov@inp.kz

**DETERMINATION OF RARE EARTHS IN URANIUM RAW MATERIAL
BY NEUTRON ACTIVATION ANALYSIS AND X-RAY FLUORESCENCE**

Abstract. Development of the rare-earth branch of the non-ferrous metallurgy is declared as a foreground direction of the Kazakhstan's national economy in the XXI century. High content of rare earth elements (REE) is a characteristic feature of various Kazakhstan's uranium deposits. To determine REE content of mineral raw materials the next non-destructive methods are the most suitable – instrumental neutron activation analysis (INAA) and X-ray fluorescence (XRF). A range of REE determination in a uranium ore by neutron activation technique is substantially impeded by the uranium fission products generating direct (La, Ce and Nd) and spectral interferences. Geological sample analysis for REE content by X-ray fluorescence suffers from insufficient sensitivity, as usual, and is restricted by the light lanthanides mainly.

In the present work, by the example of the ore samples from the Shu-Sarysu uranium provinces, the possibility of INAA method to analyze REEs under the conditions of severe interferences caused by high uranium content is considered. Light lanthanide determination by XRF at the level of their average crustal abundance is carried out with the help of a modernized energy dispersive spectrometer RLP-21T using K-series of their characteristic X-ray radiation. Comparison of La, Ce and Nd content of the uranium ore samples by INAA and XRF using the non-parametric Mann-Whitney statistical test showed that distinction of the results is statistically insignificant. Based on the uncertainty budget evaluation, maximum corrections of the analytical line count rates are assessed corresponding to the limits of quantitative and semi-quantitative determination of La, Ce and Nd by INAA. XRF was concluded as a more preferable method to analyze rocks for light lanthanide content.

Keywords: neutron activation analysis, X-ray fluorescence, rare earth elements, uranium ore.

Introduction. Due to the increased demand for the rare earth elements (REE) in the world's high-technological industries, additional sources for their extraction differing from the REE ores are searched now. REEs are often found associated with other valuable element mineralization including uranium ores which can contain appreciable REE contents [1,2]. E.g. the unique complex uranium deposit Melovoe in Kazakhstan belongs to this type [3].

Among the most common methods being used at present for REE determination in geological samples, the non-destructive techniques such as instrumental neutron activation analysis (INAA) and X-ray fluorescence (XRF) analysis can be noticed [4,5], since one of the main drawbacks of the other methods is sample decomposition.

Spectral interferences from the uranium fission products in INAA including light lanthanides were studied in details by many researchers [6-8]. Corrections are made by calculation apparent concentration of an element per 1 ppm of U or uranium k_0 -fission factors both theoretically and experimentally [9-11]. At present fission product correction algorithms embedded in the analytical software such as Kayzero for Windows work very well in routine practice and only the samples with very high uranium contents can give rise to trouble [12].

Unlike INAA, XRF analysis of geological samples for REEs is not impeded by high uranium contents, and this is its greatest advantage [13]. One of the main restrictions is caused by the lack of appropriate compact and safe sources of primary gamma-rays due to the relatively high energies of REE

K-series excitation – more than 39 keV. (100 kV X-ray tube, the out-of-production expensive XRF spectrometer Epsilon 5 is equipped with, is the single exception [14].) Therefore direct (without any preconcentration) energy dispersive XRF with isotope excitation by ^{241}Am suffers from insufficient sensitivity and can be used, as a rule, to analyse rocks only for La to Nd above their average crustal contents [15,16]. Some heavier REEs can be determined by their L-series, but the sensitivity is even worse and sophisticated algorithms must be used to overcome severe spectral interferences [17]. Wave dispersive XRF spectrometers gain the lower limits of detection due to better resolution in the low-energy region [18]; however, a preconcentration is necessary for reliable analysis for heavy lanthanide contents [19].

In this work, high sensitive energy dispersive XRF with REE K-series excitation and INAA using the XRF-based internal standard method (ISM) were applied to analyze REE content of the uranium core samples collected from a range of new sites of the Shu-Sarysu uranium provinces in Southern Kazakhstan.

Methods

A great number of grinded samples were studied by the gamma-ray spectrometric method and more than thirty of them characterized by uranium content not exceeding ≈ 500 ppm were selected. Y, La, Ce, Pr, and Nd contents of the samples were measured by XRF technique using a modified energy dispersive spectrometer RLP-21T by JSC “AspapGeo”, Almaty, Kazakhstan. 12-15 g of the powdered assays to provide “the saturated layer geometry” were pressed in Al dishes with mylar film bottom and analyzed in the automatic operating mode for twenty minutes.

The modified RLP-21T represents a new generation of reasonably priced portable XRF spectrometers since it can excite K-series of the X-ray spectra by a miniature low-powered X-ray tube. Maximum power of the X-ray tube with tungsten anode and air cooling is 10 W, and it can operate at up to 70 kV. The spectra are counted by a Peltier-cooled high-purity Si detector. No intermediate target is used due to a drastic loss of primary gamma-ray intensity. Since light lanthanide K-series is registered over the low-energy slope of the X-ray tube scattered bremsstrahlung radiation, a high-efficiency spectrum treatment algorithm is applied to calculate peak areas under the unfavourable signal-to-background ratio conditions. In order to get maximum accuracy, the element content of the samples is calculated using a reference-free modified method of the fundamental parameters.

As the spectrometer was designed to analyze geological samples, first of all, the accuracy of its software was repeatedly confirmed with the help of different corresponding certified reference materials (CRMs). E.g., the ascribed uncertainty of Fe content measuring in rock samples is (2-8)%, and this made possible to use the results of Fe analysis as an internal standard in INAA to calculate REE and other element contents [20]. RLP-21T is enrolled in the State Register of Measuring Devices, and the certified analytical technique is registered by the National Body for Certification of Kazakhstan

INAA of the same samples for the long-lived REEs only (without Pr, Dy and Er) was then carried out. About 100 mg of the assays were sealed in small double polyethylene bags, divided into several parties, and packed in Al foil for independent irradiations. A zirconium monitor to calculate epithermal to thermal neutron flux ratio $1/f$ (20 mg of ZrO_2) and about 50 μg of uranyl to evaluate the contribution of the uranium fission products were added to each package. The latter samples were prepared by drying a drop of uranyl nitrate solution pipetted on a piercing of Al foil.

To verify the accuracy of REE analysis two samples of the uranium-rich CRMs were used – OREAS 100a (uranium-bearing multi-element reference material by Australian “Ore Research & Exploration”), and OSO 528 (phosphorus-REE-uranium ore by the All-Russian Scientific Research Institute of Mineral Resources). Due to the enhanced REE contents, the sample masses were reduced to 30 mg to avoid possible self-shielding of the neutron flux. However, since the U/REE ratios of these CRMs are not too high, two additional control samples were prepared by adding about 100 μg of uranyl to 100 mg of two rock CRMs with low REE contents – GBW-07110 (trachyte andesite by the Institute of Rock and Mineral Analysis, China), and GBPG-1 (garnet biotite plagiogneiss by the A.P.Vinogradov Institute of Geochemistry, Russia).

All the packages were placed in the irradiation containers and irradiated in different days for 2.5 hours in the position № 4 inside the “wet” channel № 10-6 of the new modified active zone of the research reactor WWR-K with a typical neutron flux density $n \cdot 10^{13} \text{ cm}^{-2} \text{ s}^{-1}$.

Two high-purity Ge detectors of different types were used to collect gamma-ray spectra: an extended-range coaxial GX5019 with a relative efficiency of 50% and an energy resolution of 1.86 keV at the 1332 keV peak of ^{60}Co connected to a Canberra multi-channel analyzer DSA-1000, and a planar GLP36360 with the crystal dimensions 36x13 mm and an energy resolution of 585 eV at the 122 keV peak of ^{57}Co connected to an ORTEC multi-channel analyzer DSPEC LF. Detector calibration for relative detection efficiency was made with the help of a multi-gamma ray standard (^{152}Eu , ^{154}Eu , ^{155}Eu) and an isotopic source ^{133}Ba , both by Canberra.

The irradiated uranium ore samples were counted by the coaxial detector several times: after seven days (to analyze La, Sm, Yb), two weeks (Ce, Nd, Eu, Tb, Sc), and almost two months (Gd, Tm) of decay. Such a long time interval comparing with 30 days for usual rock analysis is necessary to make ^{239}Np X-ray $K_{\alpha 1}$ peak (103.4 keV) completely decayed since it turned out to be a serious spectral interference for the 103.2 keV line of ^{153}Gd . To avoid the same interference in the case of ^{153}Sm analysis intensity of its 69.7 keV line was measured.

The planar detector was used to analyze holmium in the ore samples by two measurements – after 6 days (t_1) of decay and after 15-17 days (t_2), when ^{166}Ho was considered completely decayed. ^{166}Ho count rate to calculate the corresponding REE content was found as follows:

$$J_{t_1}^{\text{Ho}} = J_{t_1}^{\Sigma} - J_{t_2}^{\text{Xe}} / k \exp(-\lambda_{\text{Xe}}(t_2 - t_1)),$$

where J^{Σ} is the sum peak (^{166}Ho and ^{133}Xe) count rate, λ_{Xe} – the ^{133}Xe decay constant, and factor k takes account of different measuring geometries. Due to a considerable spectral interference of 208.4 keV line of ^{208}Lu and 209.8 keV line of ^{239}Np the former line intensity was also counted by the planar detector after two or three weeks of decay depending on the uranium content.

Table 1 – Main nuclear parameters and interferences of the radionuclides used to calculate REE by INAA internal standard method

Radionuclide	Half-life, days	Energy, keV	Quantum yield, %	Interferences	Detector
^{59}Fe	44.5	1099.2	56.5		GX5019
^{46}Sc	83.8	889.3	99.9		GX5019
^{140}La	1.7	1596.2	95.4	U(n,f)	GX5019
^{141}Ce	32.5	145.4	48.3	U(n,f)	GX5019
^{147}Nd	11.0	91.1	28.1	U(n,f)	GX5019
^{153}Sm	1.9	69.7	4.7	^{187}W , ^{140}La	GX5019 GLP36360
^{152}Eu	4943	121.8	28.7		GX5019
^{153}Gd	240.4	103.2	21.1	^{153}Sm , ^{233}Pa , ^{239}Np	GX5019
^{160}Tb	72.3	298.6	26.1	^{233}Pa	GX5019
^{166}Ho	1.1	80.6	6.7	^{133}Xe , ^{131}I	GLP36360
^{170}Tm	128.6	84.3	2.5	^{182}Ta	GX5019
^{175}Yb	4.2	396.3	13.2		GX5019
^{177}Lu	6.6	208.4	10.4	^{239}Np	GLP36360
^{233}Pa	27.0	311.9	38.5		GX5019 GLP36360
^{131}I	8.0	364.5	81.5		GX5019

The main nuclear parameters of the analytical gamma-ray lines of the radionuclides used to calculate REE content, the interferences which were taken into account, and the detectors to count specific radionuclide intensities are summarized in Table 1. U(n,f) means the same radionuclide as a U fission product, whereas ^{133}Xe and ^{131}I by the uranium fission reaction appear as a spectral interference. Some minor interferences in an ordinary rock matrix were regarded as inessential and neglected. The partly resolved peaks were divided by the software.

Typical measuring time was 20-30 minutes and amounted to three hours in the case of Gd and Tm analysis because of their low content. Spectra collection was carried by the MAESTRO software (GLP36360) and by the special software developed in the Institute of Nuclear Physics (GX5019). No corrections for neutron self-shielding, gamma-ray self-absorption or true-coincidence effects were applied.

Unlike the approach where La, Ce, and Nd apparent contents are corrected for uranium fission products using U measured contents, the analytical line count rates of the corresponding radionuclides were corrected. With this end in view, the contribution coefficients F_i as the ratios of these analytical line intensities to the intensities of ^{239}Np full-energy peak and two long-lived uranium fission product (^{131}I , ^{140}Ba) peaks were estimated empirically. Once measured in certain time F_i values can be recalculated for any time of decay. ^{153}Sm peaks originating from ^{235}U fission after uranyl sample irradiations were indistinguishable in the spectra and this interference was therefore neglected.

The same variant of the single comparator method of standardization as described in [20] was applied, and REE content of the uranium ore samples were calculated according to the algorithm presented in [21]. $1/f$ ratio in the selected position by the results of a range of independent irradiations appeared to be $1/f = 0.031 \pm 0.002$ ($P = 0.95$, $\sigma = 0.001$). This ratio differs from the value evaluated in [21] because for the time elapsed beryllium reflectors were installed into the reactor's active zone.

Fe content of the uranium samples measured by XRF was used as the internal comparator to determine U, Th and the REEs analyzed by the coaxial detector. Since the intensity of 192.3 keV line of ^{59}Fe counted by the planar detector was very low, Th content of the samples was used as the internal comparator to analyze Lu, and Sm content – to analyze Ho.

Results and discussion

All the three ways of La, Ce, and Nd analytical line count rate correction were compared with the help of OSO 528 and OREAS 100a and led to almost the same contents of these REEs. Relative bias was about 1% in the case of Nd determination, <2%, and <3% in the cases of Ce and La determination, correspondingly. However, taking account of that ^{140}Ba count rate may be rather low and ^{239}Np count rate is much more affected by neutron flux spectrum composition than fission products, the ^{131}I -based correction was considered as more reliable. The results of light lanthanide analysis in the two uranium-rich CRMs using this way of correction are presented in Table 2.

As for the uranium-enriched CRMs, the measured Nd contents using the ^{131}I -based correction differed by 1% comparing with the results of initial CRM analysis, by 3% and by (3-4)% in the cases of Ce and La determination; however the assessments can be different if compared with the certified values in Table 3. To demonstrate that the loss of accuracy wasn't too high Figure 1 is adduced revealing how the correction factor $K_{\text{La,Fe}}$ for La analysis by INAA ISM was defined [20]. Only the CRMs contributing to $K_{\text{La,Fe}}$ evaluation within $\pm 5\%$ of the relative bias including 07110 and GBPG-1 (the green area) were selected. Two dark dots show deviations of La determination in the same CRMs when they were highly enriched with uranium.

The values of La, Ce, and Nd count rate corrections came up to (70-85)%. Despite the recommendation to reduce decay time of ^{140}La analysis in order to decrease its production from the reaction $^{235}\text{U}(n,f)^{140}\text{Ba} \rightarrow ^{140}\text{La}$ [11], the results after a fortnight decay (when ^{140}La decay curve becomes exponential-like) appeared to be more correct than after a week of decay, although the correction is higher. That is why two weeks of decay was implemented subsequently to analyze the uranium ore samples.

Table 2 – REE content of the uranium-rich CRMs, ppm

CRM	Element	U/REE ratio	Certified value	Measured value	Count rate correction, %
OSO 528	La	0.847	444 ± 33	439 ± 44	23.8
	Ce	0.481	782 ± 69	768 ± 77	12.1
	Nd	0.985	382 ± 25	384 ± 39	18.5
	Ho	20.3	18.5 ± 0.7	18.5 ± 2.7	44.7
	Lu	66.7	5.64 ± 0.23	5.80 ± 0.70 *	-
Oreas 100a	La	0.519	260 ± 9	267 ± 27	13.0
	Ce	0.292	463 ± 20	464 ± 47	7.9
	Nd	0.888	152 ± 8	152 ± 15	19.2
	Ho	28.1	4.81 ± 0.14	4.82 ± 0.78	59.6
	Lu	59.7	2.26 ± 0.11	2.33 ± 0.24	-

* Th content of OSO 528 is not certified and measured by INAA using GX5019 detector

Table 3 – REE content of the uranium-enriched CRMs, ppm

CRM	Element	U/REE ratio	Certified value	Measured value	Count rate correction, %
GBPG-1 (+U)	La	25.8	53.0 ± 8.0	52.2 ± 8.3	81.0
	Ce	13.1	104 ± 11	100 ± 14	75.8
	Nd	31.2	43.8 ± 7.3	44.3 ± 9.8	85.5
	Lu	4406	0.31 ± 0.05	0.32 ± 0.04	-
GBW 07110 (+U)	La	18.4	62.5 ± 2.5	57.8 ± 8.6	76.4
	Ce	9.8	117 ± 7	113 ± 16	70.7
	Nd	24.3	47.2 ± 2.5	47.3 ± 9.5	82.7
	Lu	2340	0.49 ± 0.04	0.51 ± 0.06	-

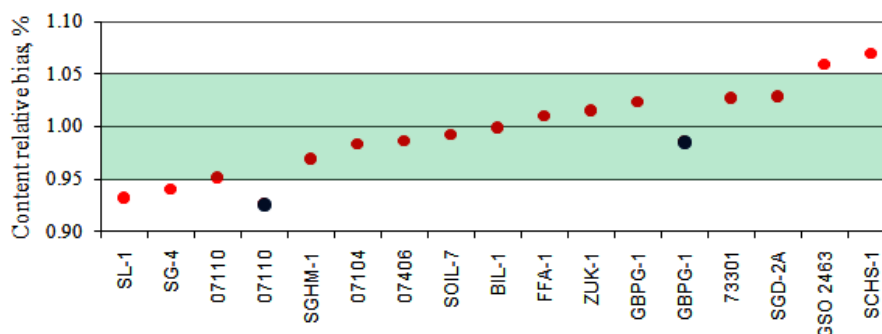

Figure 1 – Changing of La determination accuracy after 07110 and GBPG-1 CRMs were enriched with high uranium contents

Holmium measured contents of OSO 528 and OREAS 100a differed from the certified values by only 1% with ¹⁶⁶Ho count rate corrections amounted to 60%. Ho determination in the uranium-enriched CRMs appeared impossible due to very high U/Ho ratios. Lu determination in all CRMs as described above revealed the relative bias no more than 4%.

So, the CRM analysis made possible to demonstrate that the INAA ISM being used with the proposed way of uranium fission product corrections allows maintaining the precision of the method under the conditions of high U/REE ratios.

Table 4 - Comparison of La, Ce, and Nd analysis in the uranium ore samples by INAA ISM and X-ray fluorescence methods

Sample number	La content, ppm		Ce content, ppm		Nd content, ppm		U content, ppm	U/REE ratio			Count rate correction, %		
	INAA	XRF	INAA	XRF	INAA	XRF		U/La	U/Ce	U/Nd	La	Ce	Nd
1	2	3	4	5	6	7	8	9	10	11	12	13	14
1748	11.3 ± 1.8	12.2 ± 4.4	28.5 ± 3.9	29.7 ± 8.3	11.3 ± 2.1	12.0 ± 4.4	204 ± 24	17	6.9	17	81.9	66.7	80.3
3258	10.7 ± 2.6	12.1 ± 4.4	27.3 ± 4.0	29.8 ± 8.3	12.1 ± 2.8	12.9 ± 4.4	377 ± 45	31	13	29	91.2	77.4	86.1
1685	6.8 ± 3.0	5.8 ± 2.7	20.1 ± 3.5	17.4 ± 4.4	9.1 ± 3.2	7.7 ± 2.7	426 ± 51	73	24	55	95.7	86.3	91.9
8109	12.9 ± 2.4	12.8 ± 4.4	31.4 ± 4.3	32.4 ± 8.3	13.9 ± 2.6	14.3 ± 4.4	257 ± 31	20	7.9	18	86.9	70.0	80.9
282216	12.6 ± 2.1	12.0 ± 4.4	29.9 ± 4.0	27.4 ± 8.3	11.4 ± 2.0	11.4 ± 4.4	205 ± 25	17	7.5	17	82.0	62.6	77.6
282035	9.9 ± 2.5	10.5 ± 4.4	25.5 ± 3.8	24.3 ± 8.3	10.1 ± 2.6	10.2 ± 4.4	310 ± 37	29	13	30	91.7	78.4	88.0
7108	12.2 ± 2.0	10.4 ± 4.4	28.9 ± 4.0	26.8 ± 8.3	11.8 ± 2.2	11.2 ± 4.4	196 ± 23	19	7.3	18	83.2	67.9	80.5
3407	10.4 ± 1.6	11.2 ± 4.4	23.8 ± 3.5	25.4 ± 8.3	11.3 ± 2.5	12.7 ± 4.4	226 ± 27	20	8.9	18	80.1	77.4	85.0

1	2	3	4	5	6	7	8	9	10	11	12	13	14
1315	21.2 ± 4.3	23.5 ± 8.3	41.7 ± 6.0	38.0 ± 8.3	16.2 ± 3.7	17.4 ± 4.4	445 ± 53	19	12	26	88.6	75.1	85.9
440529	6.9 ± 1.2	6.9 ± 2.7	17.5 ± 2.6	16.5 ± 4.4	7.9 ± 1.8	8.1 ± 2.7	191 ± 23	28	12	24	84.0	77.9	85.7
267962	27.1 ± 3.6	26.9 ± 8.3	59.7 ± 7.9	57.5 ± 13	24.6 ± 3.6	26.4 ± 8.3	169 ± 20	6.3	2.9	6.4	54.1	47.6	62.5
4002	13.6 ± 2.0	12.5 ± 4.4	29.4 ± 4.1	27.5 ± 8.3	12.4 ± 2.3	11.8 ± 4.4	216 ± 26	17	7.8	18	75.0	71.6	80.6
5605	10.6 ± 2.5	10.2 ± 4.4	23.0 ± 3.6	23.1 ± 8.3	11.9 ± 3.0	11.4 ± 4.4	312 ± 37	31	13	27	90.7	81.8	87.6
310	44.3 ± 5.9	45.3 ± 8.3	110 ± 14	107 ± 23	46.6 ± 6.5	45.2 ± 8.3	198 ± 24	4.4	1.9	4.4	52.7	36.4	50.8
32029	28.7 ± 4.0	26.8 ± 8.3	72.2 ± 9.5	74.2 ± 13	27.8 ± 4.1	27.2 ± 8.3	258 ± 31	9.6	3.5	9.5	65.1	46.7	65.0
217	13.1 ± 2.0	12.5 ± 4.4	27.9 ± 3.8	28.1 ± 8.3	11.9 ± 2.1	13.5 ± 4.4	170 ± 20	14	6.1	13	76.1	67.0	77.1
2598	17.9 ± 2.5	19.4 ± 4.4	41.9 ± 5.6	43.0 ± 8.3	18.6 ± 2.9	18.5 ± 4.4	271 ± 32	14	6.3	15	69.1	55.2	68.5
2468	19.6 ± 2.7	19.4 ± 4.4	47.6 ± 6.5	43.9 ± 8.3	17.1 ± 3.4	18.3 ± 4.4	387 ± 46	20	8.8	21	65.3	66.9	82.3
2337	13.6 ± 2.0	12.4 ± 4.4	35.2 ± 4.6	31.8 ± 8.3	12.9 ± 2.0	13.1 ± 4.4	173 ± 21	13	5.4	13	77.1	49.7	68.5
3226	12.4 ± 1.8	11.9 ± 4.4	31.8 ± 4.3	28.6 ± 8.3	12.9 ± 2.2	11.6 ± 4.4	182 ± 22	15	6.4	16	71.7	62.4	76.6

Table 4 - (continuation). Comparison of La, Ce, and Nd analysis in the uranium ore samples by INAA ISM and X-ray fluorescence methods

Sample number	La content, ppm		Ce content, ppm		Nd content, ppm		U content, ppm	U/REE ratio			Count rate correction, %		
	INAA	XRF	INAA	XRF	INAA	XRF		U/La	U/Ce	U/Nd	La	Ce	Nd
2464	15.9 ± 2.4	17.6 ± 4.4	37.5 ± 5.2	40.2 ± 8.3	15.5 ± 3.2	17.4 ± 4.4	305 ± 37	17	7.6	17	78.0	71.2	83.9
315	17.7 ± 3.1	17.1 ± 4.4	46.5 ± 6.7	43.2 ± 8.3	15.4 ± 4.8	17.3 ± 4.4	525 ± 63	31	12	30	84.3	76.7	90.6
325	10.9 ± 2.3	12.9 ± 4.4	33.6 ± 5.1	33.1 ± 8.3	13.2 ± 4.4	13.3 ± 4.4	454 ± 54	35	14	34	89.2	81.1	91.3
2504	26.9 ± 3.7	24.9 ± 8.3	69.3 ± 9.1	60.8 ± 13	25.0 ± 3.8	23.3 ± 8.3	222 ± 27	8.9	3.7	9.5	60.1	48.6	67.7
32040	11.4 ± 2.2	12.7 ± 4.4	27.1 ± 4.2	29.3 ± 8.3	11.9 ± 3.4	12.1 ± 4.4	446 ± 54	35	15	37	87.5	82.1	89.5
323	10.8 ± 2.5	9.9 ± 2.7	28.7 ± 4.7	27.1 ± 8.3	9.8 ± 3.9	10.4 ± 4.4	406 ± 49	41	15	39	90.4	84.8	93.0
4009	17.3 ± 2.7	15.6 ± 4.4	34.7 ± 9.5	33.0 ± 8.3	14.1 ± 2.3	14.8 ± 4.4	202 ± 24	13	6.1	14	78.6	57.6	73.0
28104	14.8 ± 2.7	13.8 ± 4.4	37.3 ± 5.1	32.4 ± 8.3	14.1 ± 2.7	14.6 ± 4.4	273 ± 33	20	8.4	19	86.4	66.7	81.1
2505	17.9 ± 2.7	18.7 ± 4.4	44.9 ± 5.9	45.7 ± 8.3	17.1 ± 2.6	18.2 ± 4.4	257 ± 31	14	5.6	12	78.2	51.3	69.1
281912	14.3 ± 2.3	12.1 ± 4.4	33.4 ± 4.5	31.1 ± 8.3	12.4 ± 2.2	12.6 ± 4.4	209 ± 25	17	6.7	17	81.6	62.2	78.2
282219	6.4 ± 1.9	6.9 ± 2.7	17.4 ± 2.6	17.1 ± 4.4	6.5 ± 1.8	7.4 ± 2.7	196 ± 23	28	12	26	93.4	79.1	89.1
274820	10.1 ± 1.9	8.9 ± 2.7	24.4 ± 3.3	21.8 ± 8.3	9.8 ± 1.8	9.8 ± 2.7	181 ± 22	20	8.3	18	87.4	67.5	80.8
1409	21.0 ± 2.9	20.6 ± 8.3	41.8 ± 5.5	42.5 ± 8.3	17.8 ± 2.5	18.8 ± 4.4	118 ± 14	5.7	2.8	6.3	66.8	42.6	58.1
57111	14.3 ± 2.4	12.7 ± 4.4	32.0 ± 4.3	28.9 ± 8.3	11.8 ± 2.1	12.6 ± 4.4	197 ± 24	16	6.8	16	83.7	62.1	78.1
282923	12.2 ± 2.3	12.5 ± 4.4	28.7 ± 3.9	26.8 ± 8.3	9.0 ± 1.9	9.7 ± 2.7	179 ± 21	14	6.8	18	87.0	67.2	84.0

Table 5 - Rare earth element contents of the uranium ore samples by INAA and X-ray fluorescence methods, ppm

Sample number	Sc	Y	Pr	Sm	Eu	Gd	Tb	Ho	Tm	Yb	Lu
1748	2.40 ± 0.24	20.9 ± 8.3	5.3 ± 1.4	2.93 ± 0.35	0.585 ± 0.059	2.80 ± 0.56	0.381 ± 0.038	0.55 ± 0.19	0.236 ± 0.042	1.52 ± 0.15	0.223 ± 0.027
3258	2.21 ± 0.22	18.6 ± 4.4	5.7 ± 2.7	3.05 ± 0.37	0.663 ± 0.066	2.66 ± 0.54	0.507 ± 0.051	0.78 ± 0.38	0.237 ± 0.043	1.47 ± 0.15	0.290 ± 0.035
1685	2.73 ± 0.27	14.7 ± 4.4	3.5 ± 1.4	2.30 ± 0.28	0.544 ± 0.055	2.36 ± 0.48	0.348 ± 0.035	< 1	0.203 ± 0.037	1.31 ± 0.13	0.213 ± 0.026
8109	4.80 ± 0.48	17.5 ± 4.4	6.2 ± 2.7	3.43 ± 0.41	0.806 ± 0.081	2.75 ± 0.55	0.498 ± 0.050	0.67 ± 0.22	0.312 ± 0.056	1.63 ± 0.16	0.258 ± 0.031
282216	3.71 ± 0.37	15.1 ± 4.4	5.8 ± 2.7	3.24 ± 0.39	0.632 ± 0.063	2.92 ± 0.59	0.567 ± 0.057	1.3 ± 0.3	0.478 ± 0.086	2.69 ± 0.27	0.436 ± 0.052
282035	2.96 ± 0.30	11.4 ± 4.4	5.6 ± 2.7	2.72 ± 0.33	0.635 ± 0.064	2.22 ± 0.45	0.385 ± 0.039	0.88 ± 0.30	0.243 ± 0.044	1.38 ± 0.14	0.239 ± 0.029
7108	1.71 ± 0.17	12.1 ± 4.4	5.0 ± 1.4	2.55 ± 0.31	0.543 ± 0.055	2.16 ± 0.43	0.307 ± 0.031	0.92 ± 0.24	0.161 ± 0.029	1.02 ± 0.10	0.212 ± 0.025
3407	1.96 ± 0.20	11.4 ± 4.4	6.9 ± 2.7	2.73 ± 0.33	0.564 ± 0.057	2.52 ± 0.51	0.304 ± 0.030	1.0 ± 0.3	0.192 ± 0.035	1.17 ± 0.12	0.183 ± 0.022
1315	3.67 ± 0.37	27.2 ± 4.4	6.7 ± 2.7	4.58 ± 0.56	1.15 ± 0.12	4.42 ± 0.89	0.705 ± 0.071	< 2	0.384 ± 0.069	2.90 ± 0.29	0.611 ± 0.073
440529	1.29 ± 0.13	13.8 ± 4.4	3.5 ± 1.4	3.10 ± 0.37	0.422 ± 0.042	5.5 ± 1.1	1.39 ± 0.14	1.8 ± 0.5	0.96 ± 0.17	6.60 ± 0.66	0.99 ± 0.12
267962	13.9 ± 0.14	35.4 ± 8.3	10.0 ± 2.7	5.95 ± 0.71	1.29 ± 0.13	5.6 ± 1.2	0.905 ± 0.091	1.6 ± 0.4	0.489 ± 0.088	3.18 ± 0.32	0.465 ± 0.056
4002	2.09 ± 0.21	15.1 ± 4.4	5.8 ± 2.7	3.25 ± 0.39	0.640 ± 0.064	2.74 ± 0.55	0.377 ± 0.038	0.52 ± 0.27	0.210 ± 0.038	1.23 ± 0.13	0.205 ± 0.025
5605	2.17 ± 0.22	13.8 ± 4.4	5.5 ± 2.7	2.67 ± 0.32	0.689 ± 0.069	2.38 ± 0.48	0.335 ± 0.034	1.3 ± 0.4	0.229 ± 0.041	1.20 ± 0.12	0.248 ± 0.030
310	16.6 ± 0.17	47.4 ± 8.3	14.6 ± 4.4	10.7 ± 1.3	2.19 ± 0.22	9.2 ± 1.9	1.54 ± 0.15	2.9 ± 0.6	0.77 ± 0.14	4.34 ± 0.44	0.620 ± 0.074
32029	13.0 ± 1.3	38.1 ± 8.3	10.0 ± 2.7	5.82 ± 0.70	1.16 ± 0.12	4.49 ± 0.90	0.890 ± 0.089	2.2 ± 0.6	0.56 ± 0.10	3.27 ± 0.33	0.486 ± 0.058
217	2.11 ± 0.21	10.6 ± 4.4	6.5 ± 2.7	2.80 ± 0.34	0.681 ± 0.068	2.05 ± 0.41	0.331 ± 0.033	0.50 ± 0.20	0.156 ± 0.028	0.97 ± 0.10	0.156 ± 0.019
2598	2.23 ± 0.22	20.1 ± 8.3	6.7 ± 2.7	4.24 ± 0.51	0.749 ± 0.075	3.78 ± 0.76	0.615 ± 0.062	1.2 ± 0.3	0.269 ± 0.048	2.52 ± 0.25	0.470 ± 0.056
2468	4.68 ± 0.47	36.6 ± 8.3	7.0 ± 2.7	5.38 ± 0.65	0.845 ± 0.085	4.09 ± 0.82	0.681 ± 0.068	1.5 ± 0.4	0.389 ± 0.070	2.55 ± 0.26	0.404 ± 0.048
2337	2.58 ± 0.26	15.9 ± 4.4	4.6 ± 1.4	4.49 ± 0.54	0.565 ± 0.057	3.82 ± 0.77	0.709 ± 0.071	1.2 ± 0.3	0.507 ± 0.091	2.45 ± 0.25	0.569 ± 0.068
3226	1.93 ± 0.19	21.2 ± 8.3	4.7 ± 1.4	3.40 ± 0.41	0.643 ± 0.065	3.18 ± 0.64	0.545 ± 0.055	1.2 ± 0.3	0.322 ± 0.058	2.03 ± 0.21	0.310 ± 0.037
2464	2.84 ± 0.28	27.2 ± 8.3	6.4 ± 2.7	3.93 ± 0.47	0.647 ± 0.065	3.12 ± 0.63	0.687 ± 0.069	1.2 ± 0.3	0.472 ± 0.085	2.93 ± 0.30	0.490 ± 0.059
315	5.12 ± 0.51	22.7 ± 8.3	7.5 ± 2.7	4.42 ± 0.53	0.99 ± 0.10	4.14 ± 0.83	0.626 ± 0.063	1.4 ± 0.7	0.381 ± 0.069	2.16 ± 0.22	0.357 ± 0.043
325	3.30 ± 0.33	15.0 ± 4.4	5.1 ± 2.7	3.36 ± 0.40	0.714 ± 0.072	3.38 ± 0.68	0.688 ± 0.069	< 2	0.512 ± 0.092	3.28 ± 0.33	0.486 ± 0.058
2504	3.69 ± 0.37	33.7 ± 8.3	9.4 ± 2.7	6.47 ± 0.78	1.39 ± 0.14	6.0 ± 1.2	1.08 ± 0.11	1.8 ± 0.4	0.539 ± 0.097	3.38 ± 0.34	0.499 ± 0.060
32040	1.79 ± 0.18	18.0 ± 4.4	4.4 ± 1.4	3.41 ± 0.41	0.599 ± 0.060	3.20 ± 0.64	0.513 ± 0.051	< 2	0.273 ± 0.049	1.66 ± 0.17	0.262 ± 0.031
323	2.95 ± 0.30	13.3 ± 4.4	5.2 ± 2.7	3.09 ± 0.37	0.741 ± 0.074	2.45 ± 0.49	0.444 ± 0.045	< 2	0.248 ± 0.045	1.41 ± 0.14	0.258 ± 0.031
4009	4.01 ± 0.40	16.4 ± 4.4	6.3 ± 2.7	4.75 ± 0.57	0.716 ± 0.072	2.76 ± 0.56	0.470 ± 0.047	-	0.247 ± 0.044	1.29 ± 0.13	0.198 ± 0.024
28104	4.30 ± 0.43	17.5 ± 4.4	5.9 ± 2.7	3.92 ± 0.47	0.715 ± 0.072	3.03 ± 0.61	0.623 ± 0.062	1.1 ± 0.4	0.358 ± 0.064	2.07 ± 0.21	0.326 ± 0.039
2505	2.09 ± 0.21	23.7 ± 8.3	7.6 ± 2.7	4.18 ± 0.50	0.914 ± 0.092	4.11 ± 0.83	0.645 ± 0.065	0.64 ± 0.24	0.286 ± 0.051	1.61 ± 0.16	0.240 ± 0.039

Table 5 (continuation)											
Sample number	Sc	Y	Pr	Sm	Eu	Gd	Tb	Ho	Tm	Yb	Lu
281912	2.16 ± 0.22	16.0 ± 4.4	6.6 ± 2.7	3.36 ± 0.40	0.737 ± 0.074	3.13 ± 0.63	0.525 ± 0.053	1.0 ± 0.4	0.267 ± 0.048	1.88 ± 0.19	0.260 ± 0.031
282219	3.36 ± 0.34	14.1 ± 4.4	4.1 ± 1.4	2.20 ± 0.26	0.554 ± 0.056	2.14 ± 0.43	0.459 ± 0.046	1.4 ± 0.4	0.354 ± 0.064	2.16 ± 0.22	0.338 ± 0.041
274820	3.18 ± 0.32	16.3 ± 4.4	5.2 ± 2.7	2.67 ± 0.32	0.615 ± 0.062	2.41 ± 0.48	0.464 ± 0.047	0.85 ± 0.26	0.281 ± 0.051	1.62 ± 0.16	0.242 ± 0.029
1409	7.53 ± 0.75	19.2 ± 4.4	8.0 ± 2.7	3.94 ± 0.47	0.814 ± 0.082	3.36 ± 0.67	0.553 ± 0.056	0.89 ± 0.20	0.327 ± 0.059	2.11 ± 0.21	0.326 ± 0.039
57111	3.92 ± 0.39	15.9 ± 4.4	6.0 ± 2.7	2.98 ± 0.36	0.692 ± 0.069	2.51 ± 0.50	0.454 ± 0.046	1.3 ± 0.3	0.296 ± 0.053	1.88 ± 0.19	0.323 ± 0.039
282923	4.15 ± 0.42	17.8 ± 4.4	4.5 ± 1.4	2.88 ± 0.35	0.631 ± 0.063	2.76 ± 0.55	0.596 ± 0.060	1.6 ± 0.4	0.418 ± 0.075	2.56 ± 0.26	0.410 ± 0.049

La, Ce, and Nd contents of the uranium ore samples measured by two analytical techniques, as well as their uranium contents measured by INAA ISM, are presented in Table 4. Experimentally evaluated uranium to light lanthanide ratios and the values of count rate corrections of the corresponding radionuclides are adduced too. Table 5 summarizes the results of other REE analysis by INAA and XRF.

REE contents of the uranium ore sample turned out to be very low – from one third (Sc, La, Gd) to one (Pr) of their average crustal contents. Among the three lanthanides produced by uranium fission, U to La ratios were the highest (up to 73) with the analytical line count rate corrections coming up to 95%. The other ratios reached 24 for Ce and 55 for Nd with count rate corrections going to 86% and 93%, correspondingly. ^{166}Ho intensity corrections were also very high – from 82% to 95%. Moreover, in several cases when U content of the samples exceeded 400 ppm Ho analysis was impossible and only the upper limits were evaluated. Holmium determination in sample 4009 failed due to very high W content, about 0.095% by XRF.

The results of La, Ce, and Nd analysis by INAA and XRF were compared. Since the uranium ore samples were not selected at random, a nonparametric method of mathematical statistics should be used. The strict Mann-Whitney U -test for independent samples insensitive to variable distributions was employed. All three calculated values of the standard normal variable (0.52 is the maximum, $n = 35$) did not exceed its critical value 1.96 ($P = 0.95$) for the two-tailed test, hence the analytical results by two methods were admitted as statistically indistinguishable. Average values of La, Ce, and Nd contents of the uranium ore samples measured by INAA and XRF differed by 1% to 3.5%, while the pair-wise comparison showed discrepancy not more than 15%. Correlation between two assessments of light lanthanide contents of the uranium ore samples is depicted in Figure 2.

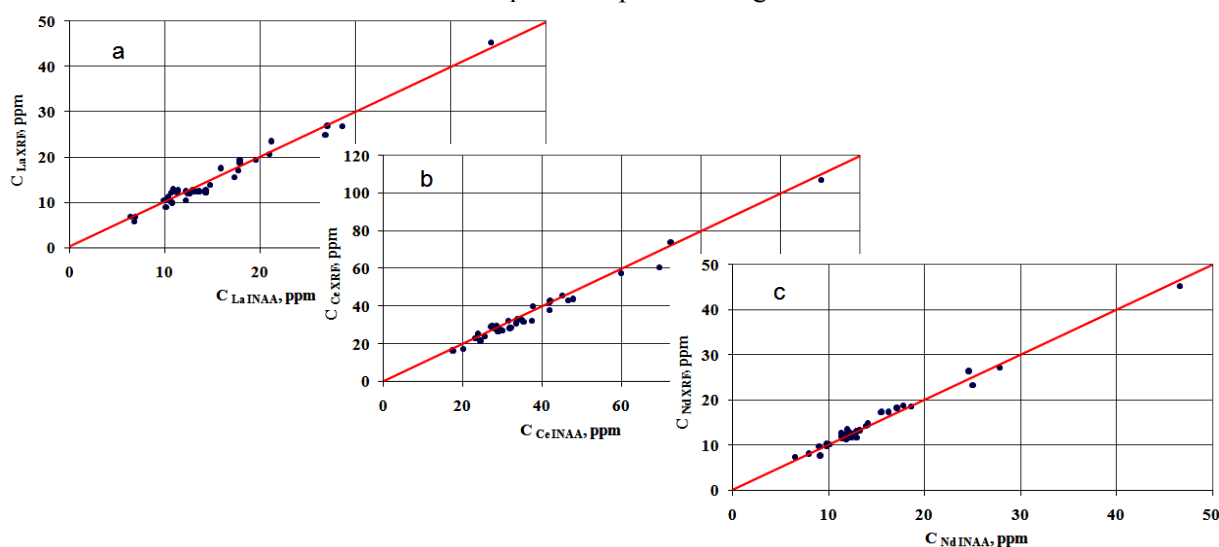

Figure 2 – Relationship between La (a), Ce (b), and Nd (c) contents of uranium ore samples by INAA and XRF

The uncertainty of REE contents by XRF corresponds to the prescribed values for every percentage interval according to the certified analytical technique and, as it was marked before, is independent of the uranium content. Unlike this, gamma-ray analytical peaks being highly impeded by the spectral interferences from the uranium fission products, INAA uncertainty sharply increases according to a hyperbolic law with the uranium content, when two close values are subtracted to receive corrected count rates. That is why uncertainty of these INAA results excites a special interest.

Main components of the uncertainty by INAA ISM were considered: Fe internal standard determination by XRF (8% for Fe contents (0.5-1)%), the methodical uncertainty of the comparator model (up to 10%), statistical uncertainties of Fe and other element counting, uncertainties of the contribution coefficients F_i evaluating. The full (enhanced) uncertainty was assessed according to the rules of error summing for correlated and uncorrelated random numbers.

Thus the evaluated enhanced uncertainty of La determination in the uranium ore samples varied from 13% to 39%, Ce – from 13% to 17%, and Nd – from 14% to 40% ($P = 0.95$). The assessed limit of La, Ce, and Nd quantitative determination by INAA (30% of uncertainty) corresponded to $\approx (91-94)\%$ correction of the analytical line intensities, and the limit of semi-quantitative determination (50% of uncertainty) corresponded to $\approx (95-97)\%$ correction. Since in the cases of high spectral corrections other sources of uncertainties become insignificant, 90% and 95% corrections may be accepted as the limits of quantitative (QL) and semi-quantitative (SQL) analysis. Larger correction gives only qualitative results (Figure 3).

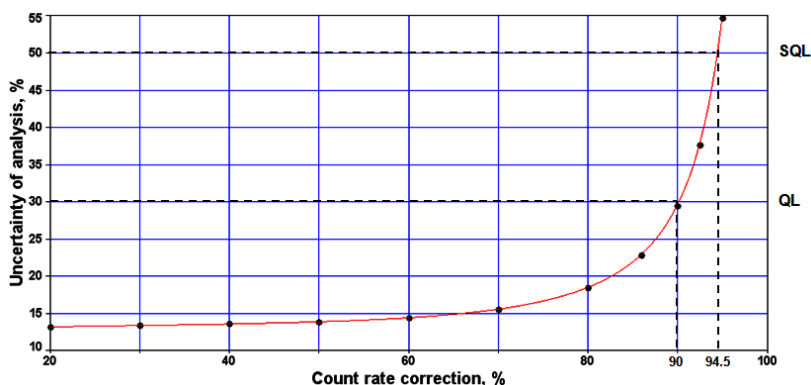

Figure 3 – Limits of Nd quantitative and semi-quantitative analysis depending on count rate correction

In spite of the planar detector resolves the sum peak ^{166}Ho and ^{133}Xe up to the background, ^{166}Ho count rate to calculate holmium content of the uranium ore samples according to the expression above turned out to be very sensitive to spectral treatment. Even a scrupulous approximation of the corresponding spectra parts is carried out (Figure 4), the uncertainty of holmium analysis by INAA evaluated in the same way varied from 21% to 55%. For more than a half from thirty five uranium ore samples holmium analysis appeared as not a quantitative one due to very high uranium fission product interference which is substantially higher than in case of light lanthanide determination. That is why holmium contents of the samples can be considered on the whole as approximate and should be treated together with the contents of other REEs only.

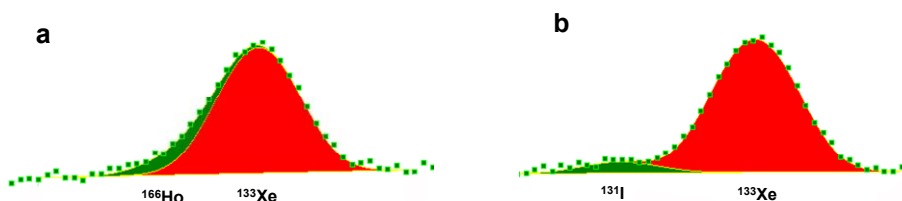

Figure 4 – A part of gamma-ray spectra treatment to calculate Ho content after 6 days (a) and 16 days (b) of decay, sample 3226

As INAA of the uranium ore samples for the rare earths which are not encumbered by the uranium fission products presented a standard procedure, it does not require a discussion.

Conclusion

Very low REE contents prevent from regarding the new sites under investigation of the Chu-Sarysu uranium provinces as a source of accompanying rare-earth primary product. However, taking the study as an example, the possibility and restrictions of REE analysis under the conditions of high U/REE ratios by XRF and INAA were investigated. The modified RLP-21T makes possible express determination of light lanthanides in the uranium ore samples with the acceptable accuracy but without any efforts which must be exerted in case of INAA ISM application. Since a new alternative of high-sensitive determination of light lanthanides in any rock samples by energy dispersive XRF appeared, it seems that INAA method should be intended to analyze heavier REE which can be accessible to XRF only in concentrates.

Acknowledgements

The work was supported by a grant from Ministry of Education and Sciences of the Republic of Kazakhstan (BR05236400).

REFERENCES

- [1] Haque N, Hughes AE, Seng Lim K, et al (2014) Rare earth elements: overview of mining, mineralogy, uses, sustainability and environmental impact, *Resources*, 3:614-635. DOI: 10.3390/resources3040614.
- [2] IAEA-TECDOC-1629 (2009) World Distribution of Uranium Deposits (UDEPO) with Uranium Deposit Classification. IAEA, Vienna. ISBN: 978-92-0-110509-7.
- [3] Naymanbayev M, Lokhova N, Baltabekova Zh (2013) Classification of raw sources of rare-earth elements in Kazakhstan, *J Mater Sci Eng B*, 5(3):326-330.
- [4] Gorbatenko AA, Revina EI (2015) A review of instrumental methods for determination of rare earth elements, *Inorg Mater*, 51:1375-1388. DOI: 10.1134/S0020168515140058.
- [5] Zawisza B, Pytlakowska K, Feist B, et al (2011) Determination of rare earth elements by spectroscopic techniques: a review, *J Anal At Spectrom*, 26:2373-2390. DOI: 10.1039/C1JA10140D.
- [6] Wasim M (2013) Interferences in instrumental neutron activation analysis by threshold reactions and uranium fission for miniature neutron source reactor, *Radiochimica Acta*, 9(101):601-606. DOI: 10.1524/ract.2013.2064.
- [7] De Corte F, Van Lierde S (2001) Determination and evaluation of fission k_0 -factors for correction of the ^{235}U (n,f) interference in k_0 -NAA, *J Radional Nucl Chem*, 1(248):97-101. DOI: 10.1023/A:1010634326208.
- [8] Landsberger S (1989) Update of uranium fission interferences in neutron activation analysis, *Chemical Geology* 1(77):65-70. DOI: 10.1016/0009-2541(89)90016-8.
- [9] Arboccò FF, Vermaereke P, Smits K, et al (2014) Experimental k_0 and k_0 -fission factors for the determination of the $n(^{235}\text{U})/n(^{238}\text{U})$ enrichment levels and correction for ^{235}U fission interferences in samples containing uranium, *J Radional Nucl Chem*, 1(302):721-735. DOI: 10.1007/s10967-014-3275-y.
- [10] Ribeiro IS, Genezini FA, Salki M, et al (2013) Determination of uranium fission interference factors for INAA, *J Radional Nucl Chem*, 2(296):759-762. DOI: 10.1007/s10967-012-2129-8.
- [11] Tshiashala MDA (2005) Instrumental neutron activation analysis in geochemistry: Emphasis on spectral and uranium fission products interference, *J Radional Nucl Chem*, 3(265):511-514. DOI: 10.1007/s10967-005-0857-8.
- [12] Stopic A, Bennett JW (2017) Application of the k_0 method to uranium ore concentrates. 7th International k_0 -Users' Workshop (Book of Abstracts), Montreal, Canada, 26.
- [13] Wu W, Xu T, Hao Q, et al (2010) Applications of X-ray fluorescence analysis of rare earths in China, *J Rare Earths*, 28 Spec. Issue:30-35. DOI: 10.1016/S1002-0721(10)60353-5.
- [14] Cevik U, Akbulut S, Makarovska Y, et al (2013) Polarized-beam high-energy EDXRF in geological samples, *Spectroscopy Letters*, 46(1):36-46. DOI: 10.1080/00387010.2012.661015.
- [15] Karivai A, Zuzaan P, Gustova V (2011) A method for the determination of some rare earth elements and their correlation with thorium using X-ray fluorescence, *Physics of Particles and Nuclei Letters*, 6(8):576-580. DOI: 10.1134/S1547477111060112.
- [16] Zuzaan P, Gansukh N, Bolortuya D (2010) Radionuclide induced energy dispersive X-ray fluorescence for the determination of La, Ce, Pr and Nd and their content sums in the rare-earth ores, *X-ray Spectrometry*, 1(39):52-56. DOI: 10.1002/xrs.1221.
- [17] Zinin DS, Bushuev NN, Kuznetsov VV (2017) X-ray fluorescence determination of La, Ce, Pr, Nd, and Sm in industrial sediments of calcium sulfate using linear regression analysis, *J Anal Chem*, 3(72):279-288. DOI: 10.1134/S1061934817030157.
- [18] Suvorova D, Khudonogova E, Revenko (2017) A X-ray fluorescence determination of Cs, Ba, La, Ce, Nd, and Ta concentrations in rocks of various composition, *X-ray Spectrometry*, 3(46):200-208. DOI: 10.1002/xrs.2747.
- [19] Orescanin V, Mikelic L, Roje V, et al (2006) Determination of lanthanides by source excited energy dispersive X-ray fluorescence (EDXRF) method after preconcentration, *Anal Chim Acta*, 2(570):277-282. DOI: 10.1016/j.aca.2006.04.028.
- [20] Silachyov I (2016) Rare earths analysis of rock samples by instrumental neutron activation analysis, internal standard method, *J Radional Nucl Chem*, 2(310):573-582. DOI: 10.1007/s10967-016-4903-5.
- [21] Silachyov I (2017) Phosphate raw material and its processing products analysis for rare earths by comparator INAA using reactor WWR-K, *News NAS RK [Izvestiya NAN RK]*, ser. chem. & techn., 6(426):103-114 (In Russian).

И. Ю. Силачѳв

РГП «Институт ядерной физики», Алматы, Казахстан

АНАЛИЗ РЕДКОЗЕМЕЛЬНЫХ МЕТАЛЛОВ В УРАНОВОМ СЫРЬЕ НЕЙТРОННО-АКТИВАЦИОННЫМ И РЕНТГЕНОФЛУОРЕСЦЕНТНЫМ МЕТОДАМИ

Аннотация. Одним из приоритетных направлений экономики Республики Казахстан в XXI веке является развитие редкоземельной отрасли цветной металлургии. Высоким содержанием редкоземельных металлов (РЗМ) характеризуются некоторые урановые месторождения РК. Для определения РЗМов в минеральном сырье наиболее подходят неdestructивные методы – инструментальный нейтронно-активационный (ИНАА) и рентгенофлуоресцентный (РФА) методы анализа. Нейтронно-активационное определение ряда РЗМов в урановой руде существенно затруднено продуктами деления урана, образующими прямые (La, Ce и Nd) и спектральные интерференции. Анализ РЗМов в геологических образцах методом РФА обычно обладает недостаточной чувствительностью и ограничен в основном легкими лантаноидами.

В данной работе на примере образцов руды Шу-Сарысуьской урановорудной провинции рассмотрена возможность метода ИНАА для определения РЗМов в условиях значительных интерференций, вызванных высоким содержанием урана. Рентгенофлуоресцентный анализ легких лантаноидов выполнен на уровне кларковых содержаний с помощью модифицированного энергодисперсионного спектрометра РЛП-21Т по К-серии их характеристического рентгеновского излучения. Сравнение содержания La, Ce и Nd в образцах урановой руды методами РФА и ИНАА с использованием критерия Манна-Уитни показало, что различие в результатах статистически незначимо. На основании анализа бюджета неопределенности оценена максимальная величина коррекции скорости счета аналитических линий, соответствующая пределу количественного и полуколичественного определения La, Ce и Nd методом ИНАА. Сделан вывод о предпочтительности метода РФА для экспрессного анализа легких лантаноидов в горных породах.

Ключевые слова: нейтронно-активационный анализ, рентгенофлуоресцентный анализ, редкоземельные металлы, урановая руда

И.Ю. Силачѳв

«Ядролык физика институты» РМК, Алматы, Қазақстан

НЕЙТРОН-АКТИВАЦИЯЛЫҚ ЖӘНЕ РЕНТГЕНФЛУОРЕСЦЕНТТІК ӘДІСТЕРІ АРҚЫЛЫ УРАНДЫҚ ШИКІЗАТТАҒЫ ЖЕРДЕ СИРЕК КЕЗДЕСЕТІН МЕТАЛДАРДЫ ТАЛДАУ

Аннотация. XXI ғасырдағы Қазақстан Республикасы экономикасының басым бағыттарының бірі түсті металлургияның жерде сирек кездесетін саласын дамыту болып табылады. ҚР кейбір уран кен орындары жерде сирек кездесетін металдардың (ЖСМ) жоғары құрамымен сипатталады. Минералдық шикізатта ЖСМ-дың болуын анықтау үшін декұрылымдық емес әдістер – аспаптық нейтрон-активациялық (АНАТ) және рентгенфлуоресцентті талдау (РФТ) әдістері ең қолайлы болып саналады. Уран кеніндегі бірқатар ЖСМ-ды нейтрон-активациялық анықтау тіке (La, Ce және Nd) және спектрлік интерференциялар түзілетін уран бөлу өнімдерімен айтарлықтай қиындық тудырады. Геологиялық үлгілердегі ЖСМ-ды РФТ әдісі арқылы талдау әдетте сезгіштігі жеткіліксіз және негізінен жеңіл лантаноидтермен шектеледі.

Осы жұмыста шалғай жатқан Шу-Сарысу уран кені кендері үлгілері ретінде уранның жоғары мөлшерімен туындаған елеулі интерференциялар жағдайында ЖСМ-ды анықтау үшін АНАТ әдісінің мүмкіндігі қарастырылған. Жеңіл лантаноидтерді рентгенфлуоресцентті талдау олардың сипаттамалық рентгендік сәулеленуінің К-топмасы бойынша РЛП-21Т модификацияланған энергия дисперсиялық спектрометрі көмегімен кларктық құрамы деңгейінде орындалды. Манна-Уитни критерийін пайдалана отырып, РФТ және АНАТ әдістерімен уран кені үлгілеріндегі La, Ce және Nd мөлшерін салыстыру нәтижелердегі айырмашылық статистикалық тұрғыдан болашы екенін көрсетті. Белгісіздік бюджетін талдау негізінде АНАТ әдісі арқылы La, Ce және Nd сандық және жартылай сандық анықтау шегіне сәйкес аналитикалық сызықтарды санау жылдамдығын түзетудің максималды мәні бағаланды. Тау жыныстарындағы жеңіл лантаноидтерді жедел талдауда РФТ әдісінің артықшылығы жөнінде қорытынды жасалды.

Түйін сөздер: нейтрон-активациялық талдау, рентгенфлуоресцентті талдау, жерде сирек кездесетін металдар, уран кені.

NEWS

OF THE NATIONAL ACADEMY OF SCIENCES OF THE REPUBLIC OF KAZAKHSTAN

SERIES CHEMISTRY AND TECHNOLOGY

ISSN 2224-5286

Volume 3, Number 429 (2018), 39 – 43

UDC 546.05+548.3+54-31+546.732:562:713:654:31

Sh.B. Kasenova¹, B.K. Kasenov¹, Zh.I. Sagintaeva¹,
M.O. Turtubaeva², E.E. Kuanyshbekov¹

¹ Zh. Abishev Chemical-Metallurgical institute, Karaganda, Kazakhstan;

² S.Toraighyrov Pavlodar State University, Pavlodar, Kazakhstan

kasenov1946@mail.ru

NEW NANO-SIZED (NANOCLUSTER) COBALT- CUPRATE - MANGANITES OF LANTHANE AND ALKALINE METALS AND THEIR X-RAY DIFFRACTION STUDY

Abstract. The search for new combined manganese, copper and cobalt-containing nanomaterials and the study of their properties is quite interesting for inorganic materials science, especially for microelectronics. Interest in such compounds is due to the polyfunctionality of the demonstrated properties and the flexibility of the composition, allowing many elements of the periodic system to be adopted.

Cobalt-cuprate-manganites of the composition $\text{LaMe}_2\text{CoCuMnO}_6$ ($\text{Me}^1 - \text{Li, Na, K}$) were synthesized by ceramic technology of lanthanum oxide (III), cobalt oxide(II), copper oxide (II), carbonates of manganese (III), lithium, sodium and potassium in the interval 800-1200 °C. After every 100 °C, the formulations were cooled, rubbed and reheated. To obtain equilibrium phases at low temperatures, low-temperature annealing was carried out at 400 °C for 10 hours. Their nanoscale (nanoclusters) particles were obtained by grinding on a vibrational mill from Retsch (Germany) of the brand "MM301". The dimensions were determined on an electronic microscope JSPM-5400 Scanning Probe Microscope "JEOL" (Japan). Prepared nanoparticles (nanoclusters) compounds of the size of 40-90 nm. X-ray phase analysis of new compounds was carried out on a DRON-2.0 unit. The analytical method of X-ray indications is established that the synthesized nanoscale new phases crystallize in cubic syngony with the following lattice parameters: $\text{LaLi}_2\text{CoCuMnO}_6 - a=11,33\pm 0,02 \text{ \AA}$; $V^0=2563,20\pm 0,06 \text{ \AA}^3$; $Z=4$; $V^0_{\text{el.cell}}=640,80\pm 0,02 \text{ \AA}^3$; $\rho_{\text{X-ray}} = 4,0 \text{ g/cm}^3$; $\text{LaNa}_2\text{CoCuMnO}_6 - a=14,43\pm 0,02 \text{ \AA}$; $V^0=3005,5\pm 0,07 \text{ \AA}^3$; $Z=4$; $V^0_{\text{el.cell}}=751,38\pm 0,02 \text{ \AA}^3$; $\rho_{\text{X-ray}} = 3,86 \text{ g/cm}^3$; $\text{LaK}_2\text{CoCuMnO}_6 - a=14,90\pm 0,02 \text{ \AA}$; $V^0=3306,90\pm 0,06 \text{ \AA}^3$; $Z=4$; $V^0_{\text{el.cell}}=826,52\pm 0,02 \text{ \AA}^3$; $\rho_{\text{X-ray}} = 3,68 \text{ g/cm}^3$. Based on X-ray phase analysis, it can be assumed that the nanoscale cobalt-cuprate-manganites obtained are related to the space group $Pm\bar{3}m$.

Key words: cobalt, cuprate, manganite, lanthanum, alkali metals, synthesis, nanoparticles, radiography.

Introduction. Cuprates, manganites, cobaltites, nickelites of rare-earth elements doped with light oxides of alkali and alkaline-earth metals have unique physical and physicochemical properties, both superconducting and semiconductor, and are also of interest as materials having giant (colossal) magnetoresistance, dielectric permittivity values. It is very important for microelectronics as substances with high operative memory [1-16].

In Zh. Abishev Chemical-Metallurgical Institute for a number of years conducted purposeful research on the synthesis and study of the physicochemical properties of double and triple manganites, chromites, ferrites, zincate-manganites, the results of which are generalized in monographs [17, 18].

Of definite scientific and practical interest is the preparation of perovskite-like compounds, where cobaltites, cuprates and manganites are represented as a single phase, like cobalt-cuprate-manganites.

For this purpose, in this work presents the results of the synthesis and study of new radiographic nanoscale (nanocluster) cobalt-cuprate-manganite composition $\text{LaMe}_2\text{CoCuMnO}_6$, where $\text{Me}^1 - \text{Li, Na, K}$.

Methods. Ceramic processing technology, X-ray phase analysis, electron microscopy.

Results of the research. The initial reagents for the synthesis were La_2O_3 (extra-pure grade), Li_2CO_3 , Na_2CO_3 , K_2CO_3 , CoO , CuO , Mn_2O_3 of qualifications "Analytical grade". Solid-phase synthesis was carried out by reacting the above substances at $800\text{--}1200^\circ\text{C}$ for 20 hours with intermittent cooling and grinding of the mixtures through 100°C . Low-temperature annealing of the mixtures was carried out at 400°C for 10 hours.

Nanosized particles of synthesized cobalt-cuprate-manganites were obtained by grinding on the vibratory mill of Retsch (Germany), brand MM301. The sizes of the crushed particles were established on an electronic microscope JSPM-5400 Scanning Probe Microscope "JEOL" (Japan). Nanoparticles (nanoclusters) from 40 to 90 nm were obtained. Below at the figure, their electron microscopic images are shown.

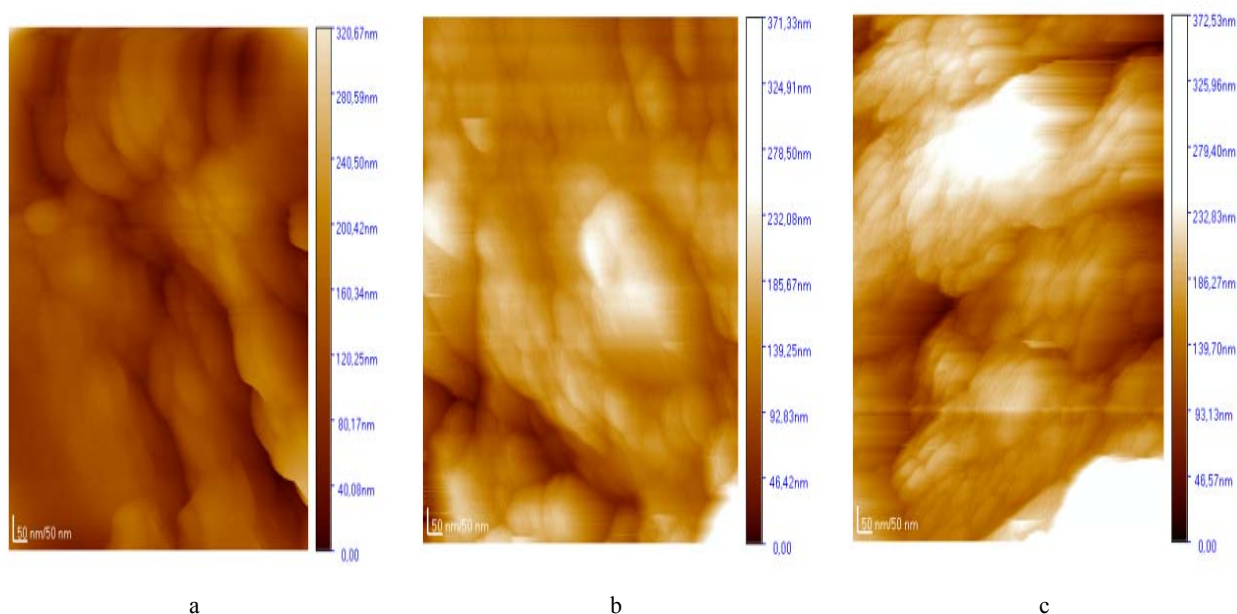

Figure – Electron microscopy $\text{LaLi}_2\text{CoCuMnO}_6$ (a), $\text{LaNa}_2\text{CoCuMnO}_6$ (b), $\text{LaK}_2\text{CoCuMnO}_6$ (c)

X-ray diffraction study of nanophases was carried out on a DRON 2.0. Conditions of shooting: CuK -radiation., Ni filter, $U = 30\text{ kV}$, $I = 10\text{ mA}$, counter rotation speed 2 rpm, scale range 1000 pulses per second, time constant, =5 seconds, angular interval 2θ from 10 up to 90 degrees. The intensity of the diffraction maxima was estimated from a one-hundred-point scale. The X-ray diffraction patterns of the compounds were determined by the analytical method [19].

Below in Table shows the of the results of the X-ray diffraction of synthesized compounds.

Satisfactory agreement of $10^4 / d_{\text{exp}}^2$ and $10^4 / d_{\text{calc}}^2$ shows the correction of the results of the indication. The imposition of X-ray radiographs indications shows that all synthesized nanoscale (nanocluster) cobalt-cuprate-manganites crystallize in a cubic system with the following lattice parameters: $\text{LaLi}_2\text{CoCuMnO}_6$ – $a=11,33\pm 0,02\text{ \AA}$; $V^0=2563,20\pm 0,06\text{ \AA}^3$; $Z=4$; $V^0_{\text{el.cell}}=640,80\pm 0,02\text{ \AA}^3$; $\rho_{\text{X-ray}} = 4,0\text{ g/cm}^3$; $\text{LaNa}_2\text{CoCuMnO}_6$ – $a=14,43\pm 0,02\text{ \AA}$; $V^0=3005,5\pm 0,07\text{ \AA}^3$; $Z=4$; $V^0_{\text{el.cell}}=751,38\pm 0,02\text{ \AA}^3$; $\rho_{\text{X-ray}} = 3,86\text{ g/cm}^3$; $\text{LaK}_2\text{CoCuMnO}_6$ – $a=14,90\pm 0,02\text{ \AA}$; $V^0=3306,90\pm 0,06\text{ \AA}^3$; $Z=4$; $V^0_{\text{el.cell}}=826,52\pm 0,02\text{ \AA}^3$; $\rho_{\text{X-ray}} = 3,68\text{ g/cm}^3$. Based on X-ray phase analysis, it can be assumed that the compounds belong to the space group $Pm\bar{3}m$.

By analogy [20, 21] it can be assumed that the ions La^+ , Li^+ , Na^+ , K^+ are in the centers of the unit cells and have coordination numbers (c.n.) in oxygen equal to 12, and at the nodes of the unit cells there are ions Co^{2+} , Cu^{2+} and Mn^{3+} , which c.n. is 6 in oxygen.

In connection with the increase in ionic radii in $\text{Li}^+ \rightarrow \text{Na}^+ \rightarrow \text{K}^+$, an increase in the "a" parameter, the volume of crystal lattices, and elementary cells is also observed.

Table - Indication of X-ray patterns of cobalt-cuprate-manganites

J/J^0	$d, \text{Å}$	$10^4/d^2 \text{ exp.}$	hkl	$10^4/d^2 \text{ calc.}$
LaLi₂CoCuMnO₆				
9	4,691	454,4	410	454,4
26	3,891	660,5	500	668,2
5	2,866	1217	631	1230
100	2,742	1330	550	1337
11	2,521	1573	553	1577
18	2,442	1677	651	1657
12	2,320	1858	653	1871
22	2,245	1984	831	1978
7	2,209	2049	832	2058
4	2,024	2441	931	2432
42	1,939	2660	10.0.0	2673
8	1,741	3299	775	3288
8	1,728	3349	10.5.0	3341
32	1,584	3985	10.7.0	3983
16	1,568	4067	12.2.2	4063
9	1,427	4911	12.6.2	4918
11	1,374	5297	14.1.1	5292
11	1,364	5375	14.2.1	5373
12	1,224	6675	10.10.7	6656
LaNa₂CoCuMnO₆				
24	5,569	322,4	320	322,4
7	4,490	496,0	420	496,0
19	3,862	670,5	511	669,6
100	2,736	1335	552	1339
14	2,315	1866	751	1860
17	2,236	2000	900	2009
51	1,932	2679	10.2.2	2678
8	1,876	2841	953	2852
5	1,846	2934	10.3.3	2916
5	1,715	3400	11.4.0	3398
36	1,581	4000	12.4.1	3993
14	1,565	4083	10.8.1	4092
3	1,501	4438	13.3.1	4439
15	1,373	5305	14.3.3	5307
11	1,360	5406	13.7.0	5406
12	1,264	6675	16.3.2	6671
12	1,217	6752	16.4.0	6746
LaK₂CoCuMnO₆				
21	3,868	668,4	520	668,4
7	3,097	1042	630	1037
6	2,867	1216	641	1222
100	2,736	1336	730	1337
16	2,527	1566	644	1567
9	2,442	1677	830	1683
14	2,320	1858	900	1867
16	2,240	1993	921	1982
5	2,130	2204	844	2213
36	1,932	2679	10.4.0	2674
6	1,873	2850	11.1.1	2835
8	1,728	3349	980	3342
27	1,580	4006	13.2.1	4010
11	1,569	4062	12.4.4	4057
11	1,373	5305	15.2.1	5301
7	1,358	5422	15.3.1	5416
8	1,229	6620	16.4.4	6638
12	1,222	6697	17.1.1	6707

Conclusion. Thus, cobalt-cuprate-manganites of the composition $\text{LaMe}^1_2\text{CoCuMnO}_6$ ($\text{Me}^1 - \text{Li, Na, K}$) were synthesized for the first time. Their nanoscale (nanocluster) particles were obtained. The type of their syngony and the parameters of the lattices were determined by X-ray diffraction.

The work was carried out in accordance with the agreement concluded between the Ministry of Education and Science of the Republic of Kazakhstan and Zh. Abishev Chemical-Metallurgical Institute under the grant of IRN AR05131317.

REFERENCES

- [1] Tretyakov YD, Brylev OA (2000) Journal of the Russian Chemical Society DI Mendeleev [Zhurnal Rossijskogo Himicheskogo Obshhestva im DI Mendeleeva] 65, 4: 10-16. (In Russian)
- [2] Portnoy KI, Timofeev NI (1986) Oxygen compounds of rare earth elements [Kislorodnye soedinenija redkozemel'nyh jelementov]. Metallurgy, Moscow. ISBN: П2605000000-138/040(01)-86
- [3] Suzdalev IP, Suzdalev PI (2001) Success of chemistry [Uspehi himii] 70, 3: 203-240. (In Russian)
- [4] Tretyakov YD, Goodilin EA (2000) Success of chemistry [Uspehi himii] 69, 1: 3-39. (In Russian)
- [5] Yerin Yu (2009) Chemistry and Chemists [Himija i himiki] 1:16-22 http://chemistry-chemists.com/N1_2009/16-22.pdf (In Russian)
- [6] Kellerman DG (2001) Success of chemistry [Uspehi himii] 70, 9: 874-889. (In Russian)
- [7] Khoronenkova SV, Eremin EA (2002) Bulletin of the Moscow State University. Chemical series [Vestnik MGU. Serija himicheskaja] 43, 5: 304-306 (In Russian)
- [8] Ivanova NB, Ovchinnikov SG, Korshunov MM, Eremin IM, Kazak NV (2009) Successes of physical sciences [Uspehi fizicheskikh nauk] 179, 8: 837-860. (In Russian)
- [9] Shevelkov AV (2008) Success of chemistry [Uspehi himii] 77, 1: 3-22. (In Russian)
- [10] Robert R, Aguirre MH, Hug P, Reller A, Weidenkaff A (2007) High-temperature thermoelectric properties of $\text{Ln}(\text{Co, Ni})\text{O}_3$ ($\text{Ln}=\text{La, Pr, Nd, Sm, Gd}$ and Dy) compounds, Acta Materialia, 55, 15: 4965-4972. <https://doi.org/10.1016/j.actamat.2007.05.020>
- [11] Klyndyuk AI, Matsukevich IV (2012) Sviridov's reading [Sviridovskie chtenija] 8:44-50. (In Russian)
- [12] Makshina EV, Borovskikh LV, Kustov AL, Mazo GN, Romanovsky (2005) Journal of Physical Chemistry [Zhurnal fizicheskoy himii] 70, 1: 253-257. (In Russian)
- [13] Balakirev VF, Barkhatov VP, Golikov YuG, Mayzel OG (2000) Manganites: equilibrium and unstable states. URO RAS, Ekaterinburg. ISBN: 5-7691-0968-8
- [14] Melkomeyeva MA, Bazuev GV (2006) Journal of Inorganic Chemistry [Zhurnal neorganicheskoy himii] 51, 3: 400-415. (In Russian)
- [15] Medvedev DA, Zhuravleva TA, Murashkina AA, Sergeeva VS, Antonov BD (2010) Journal of Physical Chemistry [Zhurnal fizicheskoy himii] 84, 9: 1777-1781. (In Russian)
- [16] Rykova AI, Cherny AS, Khatsko EN, Buchanko FN (2009) Nanomaterials [Nanomaterialy] 7, 3: 859-866. (In Russian)
- [17] Kasenov BK, Kasenova ShB, Sagintayeva ZhI, Yermagambet BT, Bekturganov NS, Oskembekov IM (2017) Double and triple manganites, ferrites and chromites of alkaline, alkaline-earth and rare-earth metals. Scientific world, Moscow. ISBN: 978-5-91522-448-2
- [18] Kasenov BK, Bekturganov NS, Yermagambet BT, Kasenova ShB, Sagintayeva ZhI, Isabaeva MA (2016) Manganites, chromites, ferrites of alkali, alkaline-earth and rare-earth metals. Litera LLP, Karaganda. ISBN: 978-601-210-194-2
- [19] Kovba LM, Trunov VK (1969) X-ray phase analysis. Publishing house of Moscow University, Moscow. ISBN: K20502-147/077(02)-76141-75
- [20] West A (1988) Solid State Chemistry. World, Moscow. Part 1. ISBN: 5-03-000056-9
- [21] Kasenov BK, Oralova AT, Mustafin ES, Zhumadilov EK (1998) Journal of Inorganic Chemistry [Zhurnal neorganicheskoy himii] 43, 2: 196-197. (In Russian)

Ш.Б. Қасенова¹, Б.Қ. Қасенов¹, Ж.И. Сағынтаева¹, М.О. Түртүбаева², Е.Е. Қуанышбеков¹

¹ Ж.Әбішев атындағы Химия-металлургия институты, Қарағанды, Қазақстан;

² С.Торайғыров атындағы Павлодар мемлекеттік университеті, Павлодар, Қазақстан

ЛАНТАН ЖӘНЕ СІЛТІЛІ МЕТАЛДАРДЫҢ ЖАҢА НАНОӨЛШЕМДІ (НАНОКЛАСТЕРЛІК) КОБАЛЬТ-КУПРАТ-МАНГАНИТТЕРІ ЖӘНЕ ОЛАРДЫ РЕНТГЕНОГРАФИЯЛЫҚ ТҮРҒЫДАН ЗЕРТТЕУ

Аннотация. Жаңа қосарласқан марганец, мыс және кобальтқұрамды наноматериалдарға ізденіс және олардың қасиеттеріне зерттеулер жүргізу бейорганикалық материалдануда, әсіресе микроэлектроника үшін елеулі қызығушылық тудырады.

Осындай қосылыстарға қызығушылық олардың берілген қасиеттерінің полифункционалдылығымен және құрамдарының периодтық жүйенің көптеген элементерін қабылдау икемділігімен байланысты.

Керамикалық технологиямен лантан (III), кобальт(II), мыс (II), марганец (III) тотықтары мен литий, натрий және калий карбонаттарынан 800-1200 °C аралықта $\text{LaMe}^1_2\text{CoCuMnO}_6$ ($\text{Me}^1 - \text{Li, Na, K}$) құрамды кобальт-купрат-манганиттері синтезделініп алынды.

Әрбір 100 °С сайын құрамдар суытылып, араластырылып және қайта қыздырылды. Төмен температурада тепе-тең фазалар алу үшін 10 сағат бойы 400 °С-та төмен температуралық қыздыру жүргізілді.

Retsch (Германия) компаниясының «ММ301» маркалы вибрациялық диірменінде үгіту жолымен олардың наноөлшемді (нанокластерлік) бөлшектері алынды, «JSPM-5400» Scanning Probe Microscope «JEOL» (Япония) электрондық микроскопында олардың өлшемдері анықталды.

Қосылыстардың өлшемі 40-90 нм болатын нанобөлшекті (нанокластері) алынды.

Жаңа қосылыстарға рентгенофазалық талдау ДРОН-2,0 дифрактометрінде жасалды. Рентгенограммаларын аналитикалық әдіспен индицирлеу барысында синтезделініп алынған наноөлшемді жаңа фазалардың тор көрсеткіштері келесідей кубтық сингонияда кристалданатыны анықталды: $\text{LaLi}_2\text{CoCuMnO}_6$ – $a=11,33\pm 0,02$ Å; $V^0=2563,20\pm 0,06$ Å³; $Z=4$; $V_{\text{эл.үя.}}^0=640,80\pm 0,02$ Å³; $\rho_{\text{рент.}} = 4,0$ г/см³; $\text{LaNa}_2\text{CoCuMnO}_6$ – $a=14,43\pm 0,02$ Å; $V^0=3005,5\pm 0,07$ Å³; $Z=4$; $V_{\text{эл.үя.}}^0=751,38\pm 0,02$ Å³; $\rho_{\text{рент.}} = 3,86$ г/см³; $\text{LaK}_2\text{CoCuMnO}_6$ – $a=14,90\pm 0,02$ Å; $V^0=3306,90\pm 0,06$ Å³; $Z=4$; $V_{\text{эл.үя.}}^0=826,52\pm 0,02$ Å³; $\rho_{\text{рент.}} = 3,68$ г/см³. Рентгенофазалық талдау негізінде алынған наноөлшемді кобальт-купрат-манганиттердің $Pm\bar{3}m$ кеңістіктік топқа жататынын болжауға болады.

Түйін сөздер: кобальт, купрат, манганит, лантан, сілтілі металл, синтез, нанобөлшектер, рентгенография.

Ш.Б. Касенова¹, Б.К. Касенов¹, Ж.И. Сагинтаева¹, М.О. Туртубаева², Е.Е. Куанышбеков¹

¹ Химико-металлургический институт им. Ж.Абишева, Караганда, Казахстан

² Павлодарский государственный университет им. С.Торайгырова, Павлодар, Казахстан

НОВЫЕ НАНОРАЗМЕРНЫЕ (НАНОКЛАСТЕРНЫЕ) КОБАЛЬТО-КУПРАТО-МАНГАНИТЫ ЛАНТАНА И ЩЕЛОЧНЫХ МЕТАЛЛОВ И ИХ РЕНТГЕНОГРАФИЧЕСКОЕ ИССЛЕДОВАНИЕ

Аннотация. Поиск новых совмещенных марганец, медь и кобальтсодержащих наноматериалов и изучение их свойств представляет определенный интерес для неорганического материаловедения, особенно для микроэлектроники. Интерес к подобным соединениям обусловлен полифункциональностью демонстрируемых свойств и гибкостью состава, позволяющий принимать многие элементы периодической системы. По керамической технологии из оксидов лантана (III), кобальта (II), меди (II), марганца (III) и карбонатов лития, натрия и калия в интервале 800-1200 °С синтезированы кобальто-купрато-манганиты состава $[\text{LaMe}_2\text{CoCuMnO}_6$ ($\text{Me}^1 - \text{Li}, \text{Na}, \text{K}$). Через каждые 100 °С составы охлаждались, перетирались и заново нагревались. Для получения равновесных фаз при низких температурах проводили низкотемпературный отжиг при 400 °С в течение 10 часов. Измельчением их на вибрационной мельнице компании Retsch (Германия) марки «ММ301» получили их наноразмерные (нанокластерные) частицы, размеры которых определены на электронном микроскопе JSPM-5400 Scanning Probe Microscope «JEOL» (Япония). Получены наночастицы (нанокластеры) соединений размером 40-90 нм. Рентгенофазовый анализ новых соединений проводили на установке ДРОН-2,0. Аналитическим методом индицирования рентгенограмм установлено, что синтезированные наноразмерные новые фазы кристаллизуются в кубической сингонии со следующими параметрами решетки: $\text{LaLi}_2\text{CoCuMnO}_6$ – $a=11,33\pm 0,02$ Å; $V^0=2563,20\pm 0,06$ Å³; $Z=4$; $V_{\text{эл.үя.}}^0=640,80\pm 0,02$ Å³; $\rho_{\text{рент.}} = 4,0$ г/см³; $\text{LaNa}_2\text{CoCuMnO}_6$ – $a=14,43\pm 0,02$ Å; $V^0=3005,5\pm 0,07$ Å³; $Z=4$; $V_{\text{эл.үя.}}^0=751,38\pm 0,02$ Å³; $\rho_{\text{рент.}} = 3,86$ г/см³; $\text{LaK}_2\text{CoCuMnO}_6$ – $a=14,90\pm 0,02$ Å; $V^0=3306,90\pm 0,06$ Å³; $Z=4$; $V_{\text{эл.үя.}}^0=826,52\pm 0,02$ Å³; $\rho_{\text{рент.}} = 3,68$ г/см³. На основании рентгенофазового анализа можно предположить, что полученные наноразмерные кобальто-купрато-манганиты относятся к пространственной группе $Pm\bar{3}m$.

Ключевые слова: кобальт, купрат, манганит, лантан, щелочные металлы, синтез, наночастицы, рентгенография.

Information about authors

Kasenov Bulat Kunurovich – Doctor of Chemical Sciences, professor, head of the laboratory thermochemical processes, Abishev Chemical-Metallurgical Institute, E-mail: kasenov1946@mail.ru, phone (work) 7212433516.

Kasenova Shuga Bulatovna – Doctor of Chemical Sciences, professor, Chief Researcher of the laboratory thermochemical processes, Abishev Chemical-Metallurgical Institute, E-mail: kasenovashuga@mail.ru, phone (work) 7212433516.

Sagintaeva Zhenisgul Imangalieвна – Cand.Sci.(Chemistry), associate professor, Leading Researcher of the laboratory thermochemical processes, Abishev Chemical-Metallurgical Institute, E-mail: kai_sagintaeva@mail.ru, phone (work) 7212433516.

Kuanyshebekov Yerbolat Yrmekovich – Master of Technical Sciences, Lead Engineer of the laboratory thermochemical processes, Abishev Chemical-Metallurgical Institute, E-mail: mr.ero1986@mail.ru, phone (work) 7212433516.

Turtubaeva Meruert Orzagalieвна – PhD in Chemistry, lecturer of the Toraiyrov Pavlodar State University, E-mail: azat-2000@bk.ru.

NEWS

OF THE NATIONAL ACADEMY OF SCIENCES OF THE REPUBLIC OF KAZAKHSTAN

SERIES CHEMISTRY AND TECHNOLOGY

ISSN 2224-5286

Volume 3, Number 429 (2018), 44 – 48

UDC 546.05+548.3+54-31+546.742:562:713: 654:31

Zh.I. Sagintaeva¹, B.K. Kasenov¹, Sh.B. Kasanova¹,
M.O. Turtubaeva², E.E. Kuanyshbekov¹

¹ – Zh. Abishev Chemical-Metallurgical Institute, Karaganda, Kazakhstan;

² – S.Toraighyrov Pavlodar State University, Pavlodar, Kazakhstan
kasenov1946@mail.ru

SYNTHESIS AND X-RAY OF NEW NANOSIZED (NANOCLUSTER) NICKELITE-CUPRATE-MANGANITES OF LANTHANUM AND ALKALINE METALS

Abstract: The main tendency in the development of microelectronics is miniaturization and increase in the speed of various devices. For storage devices, such as dynamic and static RAM, based on capacitive components (capacitors), this means that as the size of the capacitor decreases, its capacitance must remain the same [1].

The cuprates of REE are actively studied primarily as objects of high-temperature superconductivity (HTSC) compounds, cathode materials and catalysts. Lanthanum nickelites are promising materials as fuel cell cathodes.

The problems of synthesis and X-ray analysis of new nano-sized nickelite-cuprate-manganites of the composition $\text{LaMe}_2^1\text{NiCuMnO}_6$ where (Me¹-Li, Na, K) are considered for the first time in this paper.

The nickelite-cuprate-manganites of the composition $\text{LaMe}_2^1\text{NiCuMnO}_6$ (Me – Li, Na, K) are synthesized by solid-phase interaction in the range 800-1200 ° C from the oxides of lanthanum (III), nickel (II), copper (II), manganese (III) and lithium, sodium and potassium carbonates. Their nanoscale (nanoclusters) particles were obtained by grinding them on a vibratory mill "MM301" from Retsch (Germany). On the electron microscope "JSPM-5400" Scanning Probe Microscope "JEOL" (Japan) their sizes are determined. By X-ray diffraction analysis of compounds on the DRON-2.0 diffractometer and the indication of their X-ray diffraction patterns, analytical methods were used to determine the types of syngony and the parameters of the grids of the synthesized new phases: $\text{LaLi}_2\text{NiCuMnO}_6$ (cub.) – $a=13,83\pm 0,02 \text{ \AA}$, $V^{\circ}=2644,16\pm 0,06 \text{ \AA}^3$, $Z=4$, $V^{\circ}_{el.cell}=661,04\pm 0,02 \text{ \AA}^3$, $\rho_{X\text{-ray}}=4,03 \text{ g/cm}^3$; $\text{LaNa}_2\text{NiCuMnO}_6$ (cub.) – $a=14,19\pm 0,02 \text{ \AA}$, $V^{\circ}=2859,42\pm 0,06 \text{ \AA}^3$, $Z=4$, $V^{\circ}_{el.cell}=714,86\pm 0,01 \text{ \AA}^3$, $\rho_{X\text{-ray}}=3,38 \text{ g/cm}^3$; $\text{LaK}_2\text{NiCuMnO}_6$ (cub) – $a=15,17\pm 0,02 \text{ \AA}$, $V^{\circ}=3492,0\pm 0,06 \text{ \AA}^3$, $Z=4$, $V^{\circ}_{el.cell}=873,0\pm 0,01 \text{ \AA}^3$, $\rho_{X\text{-ray}}=3,70 \text{ g/cm}^3$.

Key words: nickelite, cuprate, manganite, lanthanum, alkaline metals.

Complex oxides of transition 3d- and 4f-elements with a perovskite structure closely related, e.g. manganites, nickelites, nickelates and cuprates of rare-earth elements doped with oxides of alkaline and alkaline-earth metals, due to the presence of excellent physico-chemical properties, like large values of electrical conductivity, dielectric permittivity, semiconductor conductivity, magnetic and superconducting properties [1-16].

In the laboratory of thermochemical processes of the Zh. Abishev Chemical-Metallurgical Institute conducted systematic studies on the synthesis and study of crystal-chemical, thermodynamic and electrophysical properties of manganites, chromites and ferrites doped with oxides of alkali and alkaline-earth metals. Based on the results of the research, numerous articles have been published in peer-reviewed journals with nonzero impact factors, a number of security documents have been obtained and the main results have been summarized in the following papers [17, 18].

In our opinion, for the inorganic materials science, chemistry and technology of polyfunctional compounds, it is of certain importance to obtain nickelites, cuprates and manganites in one complex, as nickelite-cuprate-manganites.

To solve this problem, we present here the results of the synthesis and X-ray analysis of new nano-sized nickelite-cuprate-manganites of the composition $\text{LaMe}_2\text{NiCuMnO}_6$ where $\text{Me}^1\text{-Li, Na, K}$.

For the synthesis of the compounds have been used lanthanum (III), mark "high purity", nickel oxide (III), copper oxide (II), manganese oxide (III), lithium, sodium and potassium carbonates of mark "analytical grade". Their stoichiometric amounts in recalculation on the formula units of the obtained nickelite-cuprate-manganites, which were thoroughly mixed and ground. The mixture was annealed at 400 °C for 10 hours to obtain stable at low-temperature modifications.

Nano-sized (nanoclusters) particles of synthesized nickelite-cuprate-manganites were obtained by grinding polycrystalline samples on a vibratory mill "MM301" from Retsch (Germany). The dimensions of the nanoclusters are determined using the "JSPM-5400" Scanning Probe Microscope "JEOL" electron microscope (Japan). Nanoparticles, nanoclusters with dimensions from 50 to 150 nm were obtained. The electron microscopic images of the connections are shown below.

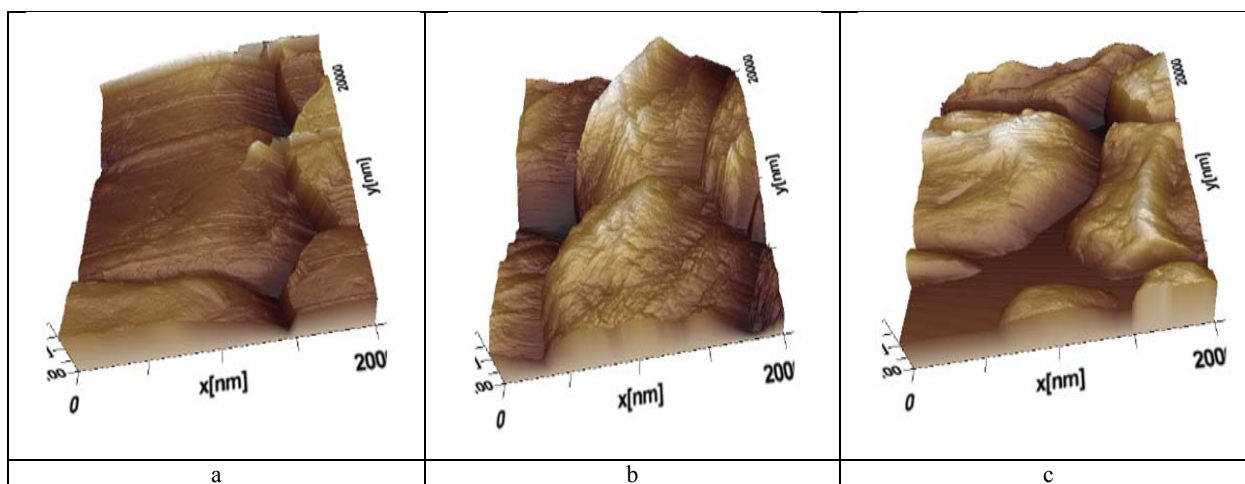

Figure – Electron microscopy $\text{LaLi}_2\text{NiCuMnO}_6$ (a), $\text{LaNa}_2\text{NiCuMnO}_6$ (b), $\text{LaK}_2\text{NiCuMnO}_6$ (c)

X-ray analysis was performed on samples of nanoscale DRON 2.0. The intensity of the diffraction maxima was estimated from a 100-point scale. The X-ray diffraction of new nanosized compounds was carried out by an analytical method [19].

The table shows the results of the indication of the new phases obtained.

Table - Indication of the X-ray radiographs of nickelite-cuprate-manganites

1/ l°	d, Å	$10^4/d^2_{\text{exp}}$	hkl	$10^4/d^2_{\text{calc}}$
1	2	3	4	5
$\text{LaLi}_2\text{NiCuMnO}_6$				
20	4,777	438,2	400	438,0
28	3,862	670,5	500	684,7
100	2,721	1351	700	1342
14	2,522	1572	722	1561
11	2,431	1692	651	1628
11	2,321	1856	820	1862
21	2,235	2002	830	1999
20	2,211	2046	751	2054
19	2,071	2332	920	2328
33	1,932	2679	853	2684
20	1,911	2738	10.0.0	2739
10	1,720	3380	11.1.1	3369
27	1,580	4006	11.5.0	3999
25	1,565	4083	10.7.0	4081
11	1,465	4659	13.1.0	4656

<i>Table continuation</i>				
1	2	3	5	6
7	1,422	4945	10.9.0	4957
9	1,371	5320	13.5.0	5313
10	1,220	6719	15.4.2	6710
8	1,210	6830	10.10.7	6819
LaNa ₂ NiCuMnO ₆				
21	3,862	670,5	510	670,0
5	3,599	772,0	521	773,7
6	3,458	836,3	440	825,2
5	3,061	1067	621	1057
100	2,735	1337	640	1341
10	2,520	1575	650	1573
14	2,4310	1692	811	1702
11	2,324	1851	660	1857
7	2,201	2064	840	2063
10	2,102	2263	664	2269
47	1,9300	2685	862	2682
4	1,8550	2906	870	2914
8	1,736	3318	881	3327
9	1,718	3388	11.3.1	3378
36	1,582	3996	975	3997
LaK ₂ NiCuMnO ₆				
14	3,865	669,4	520	669,0
100	2,742	1330	730	1339
15	2,526	1567	644	1570
12	2,420	1708	750	1708
13	2,329	1844	840	1847
18	2,240	1993	655	1985
15	2,094	2281	755	2285
35	1,935	2671	10.4.0	2678
4	1,858	2897	10.5.1	2908
5	1,730	3341	12.1.0	3347
28	1,582	3996	12.5.2	3993
9	1,479	4572	13.5.2	4570
4	1,263	6269	16.4.0	6279
10	1,224	6675	17.0.0	6671
4	1.210	6830	16.6.2	6832

Satisfactory agreement between experimental and calculated values of $10^4/d^2$ confirms the correctness of the indexing results (table). Based on the indication of the X-ray patterns of the new nanoscale (nanocluster) phases established that they crystallize in a cubic system with the following lattice parameters: LaLi₂NiCuMnO₆ (cub.) – $a=13,83\pm 0,02$ Å, $V^o=2644,16\pm 0,06$ Å³, $Z=4$, $V^o_{el.cell}=661,04\pm 0,02$ Å³, $\rho_{X-ray}=4,03$ g/cm³; LaNa₂NiCuMnO₆ (cub.) – $a=14,19\pm 0,02$ Å, $V^o=2859,42\pm 0,06$ Å³, $Z=4$, $V^o_{el.cell}=714,86\pm 0,01$ Å³, $\rho_{X-ray}=3,38$ g/cm³; LaK₂NiCuMnO₆ (cub.) – $a=15,17\pm 0,02$ Å, $V^o=3492,0\pm 0,06$ Å³, $Z=4$, $V^o_{el.cell}=873,0\pm 0,01$ Å³, $\rho_{X-ray}=3,70$ g/cm³. According to [20, 21], it can be assumed that the ions La³⁺ and Me⁺ (Li⁺, Na⁺, K⁺) are in the centers of the unit cells and have coordination numbers (kp) in oxygen equal to 12, and in the nodes of the elementary cells there are Ni²⁺, Cu²⁺ and Mn³⁺, which c.n. in oxygen are equal to 6.

There is a pattern which is that with increasing of ionic radius among Li→Na→K also increasing the values of the lattice parameters (a , V^o , $V^o_{el.cell}$).

Summarizing the foregoing, we can say that the nickle-cuprate-manganites LaMe₂^INiCuMnO₆ (Me^I – Li, Na, K) were synthesized for the first time by the method of ceramic technology. Their nanosized (nanoclusters) particles were obtained, and their lattice parameters were also determined.

The work was carried out in accordance with the agreement concluded between the Ministry of Education and Science of the Republic of Kazakhstan and Zh. Abishev Chemical-Metallurgical Institute under the grant of IRN AR05131333.

REFERENCES

- [1] Yerin Yu (2009) Chemistry and Chemists [Himija i himiki] 1: 16-22. <http://chemistryandchemists.narod.ru>. (In Russian).
- [2] Matveenko YA (2008) Physical properties of the solid solutions of $\text{La}_{2-x}\text{Ca}_x\text{NiO}_{4+\delta}$: abstract on the dissert. thesis...cand. of physico-mathematical sciences [avtoref. diss....kand. fiz.- mat. nauk.] Moscow 119. (In Russian).
- [3] Melkozerova MA, Zabolotskaya EV, Kellerman DG, Semenova AS, Medvedev EYu, Bazuev GV (2011) Solid state physics [Fizika tverdogo tela] 53, 2: 302-307. (In Russian).
- [4] Tretyakov YuD, Brylev OA (2000) Journal of the Russian Chemical Society. DI. Mendeleev's [Zhurnal Rossijskoe Himicheskoe Obshestvo im. D.I. Mendeleeva] 45, 4: 10-16. (In Russian).
- [5] Norpoth J, Su D, Inada H, Sievers S, Zhu Y, Jooss Ch. (2012) Interfacial reconstruction and superconductivity in cuprate-manganite multilayers of $\text{YBa}_2\text{Cu}_3\text{O}_7$ and $\text{Pr}_{0.68}\text{Ca}_{0.32}\text{MnO}_3$, New Journal of Physics, 14/ 093009: 1-15. <https://doi.org/10.1088/1367-2630/14/9/093009> (In Eng.).
- [6] John Y, Wei T (2002) Spin-Injection Quasiparticle Nonequilibrium in Cuprate/Manganite Heterostructures, *Journal of Superconductivity*, 15, 1: 67–70 <https://doi.org/10.1023/A:1014079211158> (In Eng.).
- [7] Fedorchenko V.P., Lashkarev G.V., Zyryn A.V., Matveenko E.A., Malkin E.I. (2006) Electrical and magnetic properties of lanthanum nickelite doped with calcium $\text{La}_{2-x}\text{Ca}_x\text{NiO}_4$ at $x = 0; 0.1; 0.2; 0.3; 0.4$ [Jelektricheskie i magnitnye svojstva nikelita lantana legirovannogo kal'ciem $\text{La}_{2-x}\text{Ca}_x\text{NiO}_4$ pri $x = 0; 0.1; 0.2; 0.3; 0.4$] III International Conference on Crystal Physics "Crystallophysics of the 21st Century", Moscow. P. 120. (In Russian).
- [8] Miao-Miao Deng, Bang-Kun Zou, Yu Shao, Zhong-Feng Tang, Chun-Hua. (2017) Chen Comparative study of the electrochemical properties of $\text{LiNi}_{0.5}\text{Mn}_{1.5}\text{O}_4$ doped by bivalent ions (Cu^{2+} , Mg^{2+} and Zn^{2+}), *Journal of Solid State Electrochemistry*, 21, 6: 1733-1742. <https://doi.org/10.1007/s10008-017-3545-z> (In Eng.).
- [9] Sen Chen, Enshan Han, Han Xu, Lingzhi Zhu, Bin Liu, Guangquan Zhang Min Lu. (2017) P_2 -type $\text{Na}_{0.67}\text{Ni}_{0.33-x}\text{Cu}_x\text{Mn}_{0.67}\text{O}_2$ as new high-voltage cathode materials for sodium-ion batteries, *International Journal Ionics*, 23, 11: 3057-3066. <https://doi.org/10.1007/s11581-017-2122-x> (In Eng.).
- [10] Yang-huan Zhang, Ya-qin Li, Hong-wei Shang, Ze-Ming Yuan, Tai Yang, Shi-hai Guo. (2017) Structures and hydrogen storage performances of rare earth-Mg-Ni-Mn-based AB_2 -type alloys applied to Ni-MH battery, *Journal of Solid State Electrochemistry*, 21, 4: 1015–1025. <https://doi.org/10.1007/s10008-016-3455-5> (In Eng.).
- [11] Archana Singh, Ajendra Singh, Satyendra Singh, Poonam Tandon, R. R. Yadav. (2016) Synthesis, Characterization and Gas Sensing Capability of $\text{Ni}_x\text{Cu}_{1-x}\text{Fe}_2\text{O}_4$ ($0.0 \leq x \leq 0.8$) Nanostructures Prepared via Sol-Gel Method, *Journal of Inorganic and Organometallic Polymers and Materials*, 26, 6: 1392–1403. <https://doi.org/10.1007/s10904-016-0428-1> (In Eng.).
- [12] Zi-Zhen Lin, Cong-Liang Huang, Wen-Kai Zhen, Yan-Hui Feng, Xin-Xin Zhang and Ge Wang (2017) Experimental Study on Thermal Conductivity and Hardness of Cu and Ni Nanoparticle Packed Bed for Thermoelectric Application, *Nanoscale Research Letters*, 12:189. <https://doi.org/10.1186/s11671-017-1969-0> (In Eng.).
- [13] Pashchenko AV, Pashchenko VP, Prokopenko VK, Silcheva AG, Revenko YuF, Shemyakov AA, Kissel HG, Sychev VYa, Gorban SV, Pogrebnyak VG (2012) Physics of a solid body [Fizika tverdogo tela] 54, 4: 720-729. (In Eng.).
- [14] Demina AN (2006) Phase individuality, structure, thermal and electrical properties of doped lanthanum manganites $\text{La}_{1-x}\text{Sr}_x\text{Mn}_{1-y}\text{M}_y\text{O}_{3\pm\delta}$ ($M = \text{Ti, Fe, Ni}$): abstract on the dissert. thesis...cand. of chemical sciences [avtoref. diss....kand. him. nauk.], Yekaterinburg. 26. (In Russian).
- [15] Garayeva M Ya, Chernykh I A, Krylova T S, Shainurov R I, Krasnoperov E P, Zanaevskin M L (2014) Letters to JTF [Pis'ma v ZhTF] 40, 20: 47-53. (In Russian).
- [16] Ali Tarjomannejad, Aligholi Niaei, María José Illán Gómez, Ali Farzi, D ariush Salari, Vicente Albaladejo-Fuentes. (2017) NO+CO reaction over $\text{LaCu}_{0.7}\text{B}_{0.3}\text{O}_3$ ($B = \text{Mn, Fe, Co}$) and $\text{La}_{0.8}\text{A}_{0.2}\text{Cu}_{0.7}\text{Mn}_{0.3}\text{O}_3$ ($A = \text{Rb, Sr, Cs, Ba}$) perovskite-type catalysts, *Journal of Thermal Analysis and Calorimetry*, 129, 2: 671–680. <https://doi.org/10.1007/s10973-017-6264-x> (In Eng.).
- [17] Kasenov BK, Kasenova ShB, Sagintayeva ZhI, Yermagambet BT, Bekturganov NS, Oskembekov IM (2017) Double and threefold manganites, ferrite and chromites alkaline, alkaline-earth and rare-earth metals. "The scientific world", Moscow. ISBN 978-5-91522-448-2.
- [18] Bekturganova AZh, Kasenova ShB, Sagintayeva ZhI, Kasenov BK, Rustembekov KT, Stoyev M. (2017) Calorimetric study of the heat capacity of nickelitic manganites $\text{LaM}_2\text{NiMnO}_5$ ($M = \text{Li, Na, K}$) in the temperature range 298.15-673 K, *High Temperature*, 55, 3: 465-468. <https://doi.org/10.1134/S0018151X17030026> (In Eng.).
- [19] Kovba LM, Trunov VK (1969) X-ray phase analysis MSU publishing house, M. K 20502-147/077(02)-76 141-75.
- [20] Vest A (1988) Chemistry of a solid body World, M. ISBN 50-03-000056-9.
- [21] Kasenov B K, Oralova A T, Mustafin E S, Zhumadilov E K (1998) Journal inorganic chemistry [Zhurnal neorgan. Himii] 43, 2: 196-197.

Ж.И. Сағынтаева¹, Б.Қ. Қасенов¹, Ш.Б. Қасенова¹, М.О. Түртүбаева², Е.Е. Қуанышбеков¹

1 - Ж. Әбішев атындағы Химия-металлургия институты, Қарағанды қ.

2 – С. Торайғыров атындағы Павлодар мемлекеттік университеті, Павлодар қ.

**ЖАҢА НАНОӨЛШЕМДІ (НАНОКЛАСТЕРЛІК) НИКЕЛИТ-КУПРАТ-МАНГАНИТТЕРДІҢ
СИНТЕЗІ ЖӘНЕ РЕНТГЕНОГРАФИЯСЫ**

Аннотация. Микроэлектрониканың дамуындағы негізгі тенденция болып түрлі құрылғылардың тезесеретуін ұлғайту мен оларды миниатюризациялау болып табылады.

Динамикалық және статикалық оперативтік жадылар сияқты сыйымдылық компоненттерге (конденсаторларға) негізделген жадыда сақтау құрылғыларда, бұл деген конденсатордың өлшемі кішірейтілген кезде оның сыйымдылық шамасы бұрынғыдай қалу керек [1].

СЖЭ купраттары бәрінен бұрын жоғарытемпературалы асқынөткізгішті (ЖТАӨ) үлгілер, катодты материалдар және катализаторлар ретінде белсенді зерттелуде.

Лантан никелиттері жану ұяшықтарында катод ретінде келелі материалдар болып табылады.

Берілген жұмыста алғаш рет $\text{LaMe}_2\text{NiCuMnO}_6$ мұндағы ($\text{Me}^1 - \text{Li, Na, K}$) құрамды жаңа наноөлшемді никелит-купрат-манганиттердің синтезі және рентгенографиялық талдау сұрақтары қарастырылған.

Лантан (III), никель (II), мыс (II), марганец (III) тотықтары және литий, натрий және калий карбонаттарының қатты фазалы әрекеттесуі арқылы 800-1200°C аралықта $\text{LaMe}_2\text{NiCuMnO}_6$ ($\text{Me} - \text{Li, Na, K}$) құрамды никелит-купрат-манганиттері синтезделініп алынды.

Retsch (Германия) компаниясының «ММ301» маркалы вибрациялық диірменінде үгіту жолымен олардың наноөлшемді (нанокластерлік) бөлшектері алынды.

«JSPM-5400» Scanning Probe Microscope «JEOL» (Япония) электрондық микроскопында олардың өлшемдері анықталды.

ДРОН-2,0 дифрактометрінде қосылыстарға рентгенофазалық талдау жүргізілді және олардың рентгенограммаларын аналитикалық әдіспен индицирлеу барысында синтезделініп алынған жаңа фазалардың сингония типі мен тор көрсеткіштері анықталды: $\text{LaLi}_2\text{NiCuMnO}_6$ (куб.) – $a=13,83\pm 0,02 \text{ \AA}$, $V^o=2644,16\pm 0,06 \text{ \AA}^3$, $Z=4$, $V^o_{\text{эл.үй.}}=661,04\pm 0,02 \text{ \AA}^3$, $\rho_{\text{рент.}}=4,03 \text{ г/см}^3$; $\text{LaNa}_2\text{NiCuMnO}_6$ (куб.) – $a=14,19\pm 0,02 \text{ \AA}$, $V^o=2859,42\pm 0,06 \text{ \AA}^3$, $Z=4$, $V^o_{\text{эл.үй.}}=714,86\pm 0,01 \text{ \AA}^3$, $\rho_{\text{рент.}}=3,38 \text{ г/см}^3$; $\text{LaK}_2\text{NiCuMnO}_6$ (куб.) – $a=15,17\pm 0,02 \text{ \AA}$, $V^o=3492,0\pm 0,06 \text{ \AA}^3$, $Z=4$, $V^o_{\text{эл.үй.}}=873,0\pm 0,01 \text{ \AA}^3$, $\rho_{\text{рент.}}=3,70 \text{ г/см}^3$.

Түйін сөздер: никелит, купрат, манганит, лантан, сілітілі металдар.

Ж.И. Сагнтаева¹, Б.К. Касенов¹, Ш.Б. Касенова¹, М.О. Туртубаева², Е.Е. Куанышбеков¹

¹ Химико-металлургический институт им. Ж. Абишева, Караганда, Казахстан;

² Павлодарский гос. университет им. С. Торайгырова, Павлодар, Казахстан

СИНТЕЗ И РЕНТГЕНОГРАФИЯ НОВЫХ НАНОРАЗМЕРНЫХ (НАНОКЛАСТЕРНЫХ) НИКЕЛИТО-КУПРАТО-МАНГАНИТОВ ЛАНТАНА И ЩЕЛОЧНЫХ МЕТАЛЛОВ

Аннотация: Основной тенденцией в развитии микроэлектроники является миниатюризация и увеличение быстродействия различных устройств. Для запоминающих устройств, вроде динамической и статической оперативной памяти, основанных на емкостных компонентах (конденсаторах), это означает, что при уменьшении размеров конденсатора величина его емкости должна оставаться прежней [1].

Купраты РЗЭ активно исследуются прежде всего как объекты высокотемпературной сверхпроводимости (ВТСП) соединений, катодные материалы и катализаторы.

Никелиты лантана являются перспективными материалами в качестве катодов топливных ячеек.

В данной работе впервые рассматриваются вопросы синтеза и рентгенографического анализа новых наноразмерных никелито-купрато-манганитов состава $\text{LaMe}_2\text{NiCuMnO}_6$ где $\text{Me}^1 - \text{Li, Na, K}$.

Твердофазным взаимодействием в интервале 800-1200°C из оксидов лантана (III), никеля (II), меди (II), марганца (III) и карбонатов лития, натрия и калия синтезированы никелито-купрато-манганиты состава $\text{LaMe}_2\text{NiCuMnO}_6$ ($\text{Me} - \text{Li, Na, K}$). Путем измельчения на вибрационной мельнице марки «ММ301» компании Retsch (Германия) получены их наноразмерные (нанокластерные) частицы. На электронном микроскопе «JSPM-5400» Scanning Probe Microscope «JEOL» (Япония) определены их размеры. Проведением рентгенофазового анализа соединений на дифрактометре ДРОН-2,0 и индицированием их рентгенограмм аналитическим методом определены типы сингонии и параметры решеток синтезированных новых фаз: $\text{LaLi}_2\text{NiCuMnO}_6$ (куб.) – $a=13,83\pm 0,02 \text{ \AA}$, $V^o=2644,16\pm 0,06 \text{ \AA}^3$, $Z=4$, $V^o_{\text{эл.үй.}}=661,04\pm 0,02 \text{ \AA}^3$, $\rho_{\text{рент.}}=4,03 \text{ г/см}^3$; $\text{LaNa}_2\text{NiCuMnO}_6$ (куб.) – $a=14,19\pm 0,02 \text{ \AA}$, $V^o=2859,42\pm 0,06 \text{ \AA}^3$, $Z=4$, $V^o_{\text{эл.үй.}}=714,86\pm 0,01 \text{ \AA}^3$, $\rho_{\text{рент.}}=3,38 \text{ г/см}^3$; $\text{LaK}_2\text{NiCuMnO}_6$ (куб.) – $a=15,17\pm 0,02 \text{ \AA}$, $V^o=3492,0\pm 0,06 \text{ \AA}^3$, $Z=4$, $V^o_{\text{эл.үй.}}=873,0\pm 0,01 \text{ \AA}^3$, $\rho_{\text{рент.}}=3,70 \text{ г/см}^3$.

Ключевые слова: никелит, купрат, манганит, лантан, щелочные металлы.

Information about authors:

Kasenov Bulat Kunurovich – Doctor of Chemical Sciences, professor, head of the laboratory thermochemical processes, Abishev Chemical-Metallurgical Institute, E-mail: kasenov1946@mail.ru, phone (work) 7212433516.

Kasenova Shuga Bulatovna – Doctor of Chemical Sciences, professor, Chief Researcher of the laboratory thermochemical processes, Abishev Chemical-Metallurgical Institute, E-mail: kasenovashuga@mail.ru, phone (work) 7212433516.

Sagintaeva Zhenisgul Imangalieвна – Cand.Sci.(Chemistry), associate professor, Leading Researcher of the laboratory thermochemical processes, Abishev Chemical-Metallurgical Institute, E-mail: kai_sagintaeva@mail.ru, phone (work) 7212433516.

Kuanyshebekov Yerbolat Yrmekovich – Master of Technical Sciences, Lead Engineer of the laboratory thermochemical processes, Abishev Chemical-Metallurgical Institute, E-mail: mr.ero1986@mail.ru, phone (work) 7212433516.

Turtubaeva Meruert Orzagalieвна – PhD in Chemistry, lecturer of the Toraygyrov Pavlodar State University, E-mail: azat-2000@bk.ru.

NEWS

OF THE NATIONAL ACADEMY OF SCIENCES OF THE REPUBLIC OF KAZAKHSTAN

SERIES CHEMISTRY AND TECHNOLOGY

ISSN 2224-5286

Volume 3, Number 429 (2018), 49 – 54

UDC 542.943-92

**A.S. Bukanova, F.B Kairlieva, L.B Sakipova,
O.Yu. Panchenko, N.A Karabasova, R.N. Nasirov**

Atyrau State University named after Kh. Dosmukhamedov, Atyrau, Kazakhstan
rnasirov.48@mail.ru

NEW APPLICATION OF OXIDATION-REDUCTION REACTIONS

Abstract. In this article, the application of new methods of oxidation-reduction reactions in three directions is considered.

Its first direction is in the role of an intermediate in the process of passage of organic reactions. When a weak CH-acid of triphenylmethane is reduced with sodium, in the first stage an anion-radical is formed and then a carbanion.

The second direction is the determination of vanadium metal in petroleum and petroleum products. In this direction, the photocolometric method was used before. Now, when burning oil residues from the ash formed (V_2O_5) by the interaction of hydrochloric acid, vanadium chloride is formed, which is determined by the EPR spectrometer. This new method is more efficient and accurate, compared to the conventional photocolometric method used in the laboratory.

In recent years, based on experiments conducted in the Atyrau region, a genetic link between nitrates and nitrite ions has been established. Members of the circle tested the content of nitrate ions in plants using diphenylamine-4-sulfonic acid sodium salt. When exposed to reagents, the nitrate ion contained in the acidic juice of the plant is oxidized and stained from slightly violet to dark blue.

Keywords: anion-radical, electron paramagnetic resonance, vanadium, ash oil, photocolometric method, nitrate ion, nitrite ion.

Introduction. In the chemistry history, it has long been asserted that oxidation occurs when the elements are combined with oxygen. For example, many metals lose their properties under the influence of oxygen and are corroded (destroyed).

If the iron lies in moist air, then its surface is covered with red-brown rust:

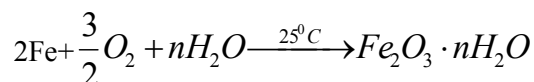

Likewise, all elements, apart from inert gases, react with oxygen and form oxides. Recently, complex physico-chemical devices and studies have shown that other chemical reactions lead to a similar conclusion. For example, metallic sodium not only reacts with oxygen, but also interacts with other compounds:

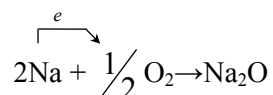

Also, sodium reacts with poisonous chlorine with the formation of an edible salt, having a unique taste and does not have its own smell:

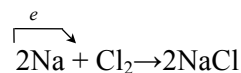

Also, sodium reacts with benzene, and gives it one electron turning into an anion-radical of the organic salt [1]:

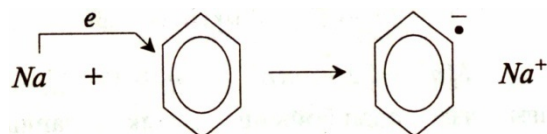

This compound has an unpaired electron that gives paramagnetic properties to benzene and has a negative charge.

When triphenylmethane reacts with sodium, it flows through the stage of the unstable anion-radical of triphenylmethane[2].

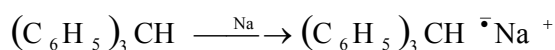

For sodium, this process is similar to each other. Since in four cases it gives up its valence electron and is oxidized.

In the first case - oxygen, in the second case - chlorine, in the third case - benzene, in the fourth case - triphenylmethane are oxidants. These reactions are simple methods of oxidation-reduction reactions.

Reaction of triphenylmethane with sodium

The mechanism of carbanion formation from the triphenylmethane compounds during the reduction with sodium occurs through the stage of the unstable anion-radical of triphenylmethane and is detected by the electron paramagnetic resonance (EPR) method.

Of the fatty-aromatic multinuclear compounds, the properties of the central carbon "methane" atom of triphenylmethane (TFM) are the most interesting. In the triphenylmethane itself, hydrogen bound to this carbon is relatively easily cleaved in the form of a proton under the action of sodium amalgam [3]:

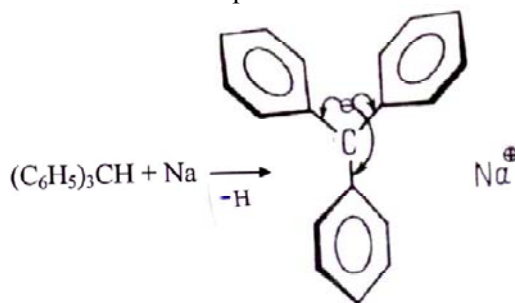

triphenylmethyl anion
(red); $\lambda=480$ nm

The stability of carbanions (triphenylmethyl anions) with phenyl nuclei is due to the conjugation of the negative charge of the central carbon atom to the π -electron system of three benzene rings [3,4]. The triphenylmethyl anion is identified by UV spectroscopy in tetrahydrofuran ($\lambda=480$ nm)

The reaction of an alkali metal with triphenylmethane at low temperature (-110 °C) in tetrahydrofuran (THF) gives a new EPR spectrum consisting of 10 lines [2]:

$$N=2nI_H+1 = 2 \cdot 9 \cdot \frac{1}{2} + 1 = 10 \text{ line}$$

and the distance between the lines $a=1,85$ Gs (рисунок 1).

This unpaired electron in two rings is delocalized and magnetically interacts with equivalent four-ortho, four-para and one-methine protons and, as a result, forms ten lines (the spin of the nucleus of hydrogen $I_H = 1/2$).

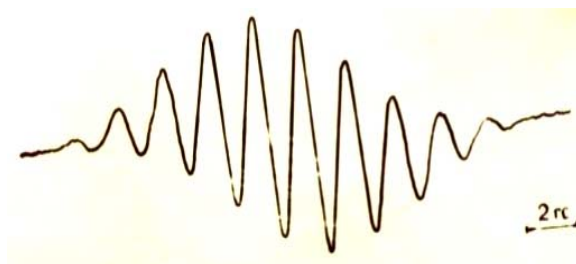
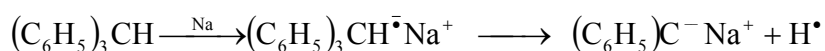

Figure 1 - The EPR spectrum of the anion-radical of triphenylmethane of green color with sodium at a temperature of -110°C .

As a result of the reaction of triphenylmethane with sodium, the anion radical of triphenylmethane (of dark greenish color) is unstable at low temperatures, and then the alkali metal replaces hydrogen and the carbanion is formed:



The description of the proposed basic mechanism getting the unstable anion radical of triphenylmethane as a reaction intermediate was directly proved by EPR spectroscopy.

The proposed scheme is also confirmed by visual observations of the transition of the green color of the anion radical to the distinctive red color of the carbanion.

At the end of the last century, in the subject of organic chemistry in all higher educational institutions, it was known that the reaction of weak CH acids with alkali metals leads to the formation of carbanions, and no word is said about the intermediate particle. [3] When reading lectures on organic chemistry, it is necessary to clarify the mechanism of this reaction. This will greatly increase students' interest in science.

Oxidizing ability of vanadium pentoxide included in the composition of oil ash with hydrochloric acid.

In order to improve the standard GOST 10364-63 chemical method for the determination of vanadium in oil and petroleum ash, we propose a more express method for estimating the total amount of vanadium in oil ash, based on the oxidizing capacity of V_2O_5 in an acidic environment of concentrated hydrochloric acid [5-7]:



In the resulting oxo-vanadyl group VO^{2+} , the central vanadium ion has one unpaired electron, as a result of which it has a paramagnetic property. The oxo-vanadyl ion VO^{2+} is highly stable and remains unchanged during the reactions, as evidenced by its EPR spectrum.

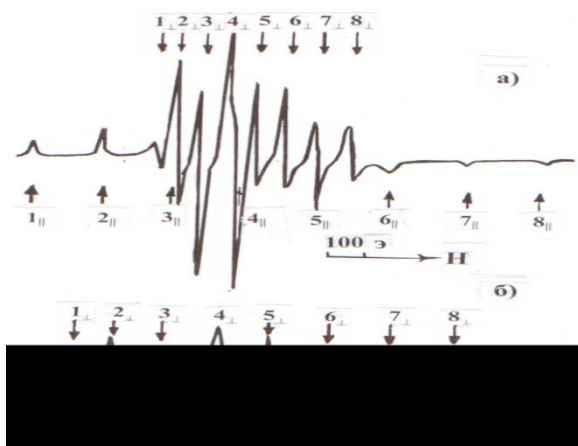

Figure 2 - The EPR spectra of vanadyl chloride at -196°C , obtained: a - from V_2O_5 ; b - from the ash of Kalamkas oil, of borehole #52, (here are written the hyperfine lines of the L_{\perp} - 8_{\perp} vanadyl ion)

Figure 2a shows the anisotropic EPR spectrum of the resulting vanadium chloride formed from reactive vanadium oxide. The same spectrum was obtained from the ash of Kalamkas oil, borehole 52 (Fig. 2b) and other oils.

The concentration of vanadium, in the studied oil ash of the Caspian region, is determined by the anisotropic EPR spectrum of vanadyl chloride formed from vanadium pentoxide at liquid nitrogen temperature (-196°C) (Table 1).

Table 1 - The content of vanadium in oils and their ash, %

Oil	Ash output	The amount of vanadium in oil		The content of vanadium in ash
		XFA	EPR	
Kalamkas, 52	0.087	0.0154	0.0148	17.5
Botakhan, 68	0.037	0.0025	0.0022	12.9
Karazhanbas, 851	0.09	0.029	0.026	28.9

As can be seen from Table 1, the results of determination of vanadium in petroleum oils by photocolometric (PEC) and EPR method in terms of oil, are consistent with the result of determination of vanadium in crude oils by XFA and EPR methods. The EPR method is more efficient and accurate than the traditional photocolometric method used in laboratories [8].

Genetic relationship between nitrite and nitrate ions

The research work for students interested in chemistry is mainly related to the needs of the Atyrau region.

The accumulation of nitrates and nitrites above the norm in crop mass, fodder, vegetables and in meat that are used as food can have an unprofitable effect on animals and human organisms, especially the properties of mutagenic nitrites in the human body is extremely dangerous.

Nitrates that enter the human or animal body when using vegetable food are restored to nitrite. The resulting nitrite ion blocks the oxygen supply to the cells and leads to serious illnesses in the body. The daily amount of nitrate for live weight should be from 300 to 320 mg or 4 mg/kg [9]. Members of the circle on the basis of their own experiments established a genetic link between the nitrates and nitrites ions[10-12]:

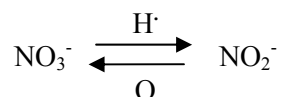

In the course of the experiment, it was found that a simpler method of transition from nitrate to nitrite is the reduction of nitrate by hydrogen in the acidic medium.

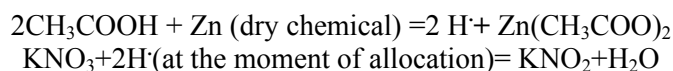

We solve the inverse problem:

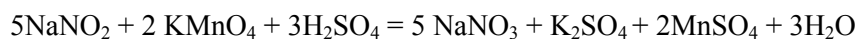

The reducing properties of nitric acid and its salt are confirmed by the disappearance of the pink color KMnO_4 .

We can test this equation by adding the Griss reagent to the solution.

Under the action of nitrite ions, the Griss reagent turns to red. Students developed an express visual technique for the mass analysis of nitrate ions in plant juices. To produce a visual scale, an aqueous solution of diphenylamine-4-sulfonic acid sodium salt was used with a known nitrate ion content[10].

Table 2 - Visual scale for determination of nitrate ion in test samples

Concentration of nitrate ion in solution, mg/l	Color of solution
<10	Bright blue
30	Blue
300	Dark blue

The development of express ions also requires, in addition to chemical knowledge, knowledge in physics (optics), biology, agrochemistry and ecology.

Conclusions

1. The mechanism of the formation of carbanion from the compounds of triphenylmethane during the reduction by sodium occurs through the stage of the unstable radical anion of triphenylmethane and is detected by the electron paramagnetic resonance (EPR) method.

The proposed scheme is also confirmed by visual observations of the transition of the green color of the anion radical to the distinctive red color of the carbanion.

2. It is proposed to use EPR - radiospectroscopy not only to estimate the amount of tetravalent vanadium in oils, but also to estimate the total amount of vanadium in oils. In the case of mass laboratory analyses characterized by selectivity, high accuracy and expressiveness, the proposed method has advantages in comparison with the photocolometric method of vanadium analysis in oils and petroleum products.

3. In the circle, students master and develop the technique for determining the content of nitrates and nitrites in crop materials.

REFERENCES

- [1] Tuttle T.R., Weissman S.I. // J. Am. Chem. Soc. **1958**. **80**. P. 5342 – 5348.
- [2] Nasirov R., Prokofiev A.I., Solodovnikov S.P., Kabachnik M.I. Anion-radical of triphenylmethane // Izvest. AN USSR, ser. Chem. 1973. № 9. S. 1981.
- [3] Perekalin V. V and Zonis S. Organic Chemistry. M.: Enlightenment. **1982**. 464 p.
- [4] Reutov O.A., Kuri A.L., Butin K.P. Organic chemistry. M.: Pilot, **2017**. 568 p.
- [5] Akhmetov N.S. General and Inorganic Chemistry. M.: Higher School. **2001**.
- [6] Nasirov R. General and inorganic chemistry. Almaty: Science. **2003**. 359 p.
- [7] Greenwood N., Earnsho A. Chemistry of Elements (in 2 volumes). M.: BINOM. Laboratory of Knowledge. **2008**.
- [8] Nasirov R. Vanadium in oil and its use in the processing, search and extraction of hydrocarbons // Reports NAS RK. **2012**. № 2. P. 34 - 38.
- [9] Golubkina N.A and Shamina M.A. Laboratory practical work on ecology. M.: FORUM: INFRA. M. **2004**. 56 p.
- [10] Nasirov R. Genetic link between ions // Kazakh school. **1988**, № 1, p. 64 - 67.
- [11] Nasirov R., Mazhitov S.M. Experimental work in the circle "Young chemist" // Chemistry in the school. **1989**. № 5. P. 108-109.
- [12] Nasirov R., Baymukasheva G.K., Matveeva E.F. Experiment of interdisciplinary nature in the classroom // Chemistry in school. **2008**, 4, P. 64 - 70.

ӨОК 542.943-92

**А.С. Буканова, Ф.Б. Қайрлиева, Л.Б. Сақипова,
О.Ю. Панченко, Н.А. Қарабасова, Р.Н. Насиров**

Х. Досмұхамедов атындағы Атырау мемлекеттік университеті

ТОТЫҒУ – ТОТЫҚСЫЗДАНУ РЕАКЦИЯЛАРЫНЫҢ ЖАҢА ҚОЛДАНЫЛУЫ

Аннотация. Бұл мақалада тотығу – тотықсыздану реакцияларының жаңа қолданысы үш бағытта айқындалды. Оның бірінші бағыты жоғарғы оқу орындары химиясын оқуда органикалық реакциялардың жүру барысында интермедиат ретіндегі рөлі. Әлсіз СН – қышқылы үшфенилметанның натириймен тотықсыздануы кезінде ең бірінші сатыда анион – радикал түзілетіні ұсынылды, ал одан кейін карбанион өнімі алынады.

Екінші бағыт мұнай және мұнай өнімдерінде ванадий металын анықтау ісі. Бұл ретте осы кезеңге дейін фотоколориметрлік әдіс қолданылып келді. Енді мұнайды жағып оның күлінен (V_2O_5) қойылтылған тұз қышқылымен әсер ету арқылы хлорлы ванадийді алып, оны ЭПР – спектрометрмен анықтау ісі. Бұл жаңа әдіс зертханада қолданылып жүрген дәстүрлі фотоколориметрлік әдіске қарағанда аса тиімді және дәлдігіде өте жоғары.

Соңғы жылдары Атырау облысында өздері жүргізген тәжірибелер негізінде нитрат және нитрит ионы арасындағы генетикалық байланысты тағайындады. Үйірме мүшелері өсімдік суындағы нитрат ионды экспресті анықтау үшін екі фениламин- 4-сульфоқышқыл натрий тұзын сынақтан өткізді. Ол нитрат

ионының реактиві ретінде қышқыл ортада өсімдік сөліндегі нитрат-ион әсерінен тотығып, оның мөлшеріне сай әлсіз күлгін түстен сияқөк түске дейін боялатын өнім береді.

Түйін сөздер: анион – радикал, электрондық парамагниттік резонанс, ванадий, мұнай күлі, фотоколориметрлік әдіс, нитрат ион, нитрит ион.

УДК 542.943-92

**А.С. Буканова, Ф.Б.Кайрлиева, Л.Б.Сакипова,
О.Ю.Панченко, Н.А.Карабасова, Р.Н. Насиров**

Атырауский государственный университет им.Х.Досмухамедова

НОВОЕ ПРИМЕНЕНИЕ ОКИСЛИТЕЛЬНО-ВОССТАНОВИТЕЛЬНЫХ РЕАКЦИЙ

Аннотация. В этой статье рассмотрено применение новых способов окислительно-восстановительных реакций по трем направлениям.

Его первое направление в роли интермедиата в процессе прохождения органических реакции. При восстановлении слабой СН-кислоты трифенилметана натрием в первой стадии образуется анион-радикал и после этого карбанион.

Второе направление - определение металла ванадия в нефтях и нефтепродуктах. В этом направлении раньше использовался фотоколориметрический метод. Теперь, при сжигании нефтяных остатков из образовавшейся золы (V_2O_5) взаимодействием соляной кислоты, образуется хлорид ванадия, который определяется с помощью ЭПР – спектрометра. Этот новый метод является более эффективным и точным, по сравнению с обычным фотоколориметрическим методом, применяемый в лаборатории.

В последние годы, основываясь на экспериментах, проведенных в Атырауской области, установили генетическую связь между нитратами и нитритными ионами. Члены кружка протестировали содержание нитрат-ионов в растениях с использованием дифениламин-4-сульфокислот натриевой соли. Нитрат-ионом в кислой среде растения при воздействии дифениламин-4-сульфокислот натриевой соли окисляется и окрашивается от слабо фиолетового до темно синего цвета.

Ключевые слова: анион – радикал, электронный парамагнитный резонанс, ванадий, зола нефти, фотоколориметрический метод, нитрат ион, нитрит ион.

Сведения об авторах:

Буканова Айгуль Сокеевна – к.т.н., доцент, зав.кафедрой «Химия и химическая технология»;

Кайрлиева Фазилат Басаровна – к.т.н., ст. преподаватель кафедрой «Химия и химическая технология»;

Сакипова Лидия Багитжановна – магистр, ст. преподаватель кафедрой «Химия и химическая технология»;

Панченко Ольга Юрьевна - магистр, ст. преподаватель кафедрой «Химия и химическая технология»;

Карабасова Нагима Асылбековна - магистр, ст. преподаватель кафедрой «Химия и химическая технология»;

Насыров Рахметулла – д.х.н., профессор кафедры «Химия и химическая технология».

NEWS

OF THE NATIONAL ACADEMY OF SCIENCES OF THE REPUBLIC OF KAZAKHSTAN

SERIES CHEMISTRY AND TECHNOLOGY

ISSN 2224-5286

Volume 3, Number 429 (2018), 55 – 60

УДК 542.8:544.14:539.19

A.M. Tatenov, V.V. Savelyeva, A.S. Kaliev

Euroasian technological university, Almaty, Kazakhstan.

tatenov_adambek@mail.ru, vika-sova@mail.ru**THE MECHANISM OF COMPOUND OF CHEMICAL ELEMENTS
FOR THE TABLE OF D.I. MENDELEYEV AND THE VIRTUAL
INTERAKTIVIZATION IN THE PROGRAM ENVIRONMENT
FLASH-CC, JAVA SCRIPT**

Abstract. It is asked creations of the virtual interactive laboratories with obviousness of deep mechanisms of chemical reactions at the atomic level in inorganic chemistry.

On the basis of a research practical use of results of the virtual laboratory operated (interactive) with visualization and animation of mechanisms course of processes, on inorganic and organic chemistry are planned. Will be applied to upgrading of tutoring, big saving of time (about 60% for assimilation of a subject), to self-contained carrying out research works, to development of creativity of students. The product will be used all system of secondary education (schools, lyceums, gymnasiums), all system of the higher education where study chemistry, research institutes and laboratories and also food, chemical, pharmaceutical, other technological industries.

Keywords: periodic system of elements, atom, electron, proton, neutron, atomic weight, Pauli's exclusion principle, rule Hunda, orbital, energy levels, valence.

Introduction. The periodic law – the greatest achievement for chemical science, fundamentals of all modern chemistry. With its opening the chemistry stopped being descriptive science, in it scientific anticipation became possible.

The periodic law is opened by D.I. Mendeleev in 1869. The scientist formulated this law so: "Properties of simple bodies, also forms and properties of connections of elements are in periodic dependence on the size of atomic weights of elements" [1, 2].

More detailed studying of a structure of substance showed that frequency of properties of elements is caused not by atomic weight, but an electronic structure of atoms.

Nuclear charge is the characteristic defining an electronic structure of atoms and consequently, and properties of elements. Therefore in the modern formulation the Periodic law sounds: properties of simple substances and also forms and properties of connections of elements are in periodic dependence on ordinal value (from the size of nuclear charge of their atoms). Expression of the Periodic law is the periodic system of elements.

Periodic system of D.I. Mendeleev

The periodic system of elements of D.I. Mendeleev consists of seven periods which represent the horizontal sequences of elements located on increase of a charge of their atomic nucleus. The periods 1, 2, 3, 4, 5, 6 contain respectively 2, 8, 8, 18, 18, 32 elements. The seventh period is not complete. The periods 1, 2 and 3 call small, the others - larger.

Every period (except for the first) begins atoms of alkali metals (Li, Na, To, Rb, Cs, Fr) and comes to an end with a rare gas (Ne, Ar, Kr, Xe, Rn) to which typical nonmetal precedes. In the periods from left to right metal gradually weaken and nonmetallic properties as with body height of positive charge of atomic nuclei the number of electrons at the external level increases amplify [2].

In the first period, except helium, there is only one element - Hydrogenous. It is conditionally placed in IA or VIIA to subgroup as he shows similarity and to alkali metals, and to halogens. The similarity of Hydrogenous to alkali metals is shown that Hydrogenous, as well as alkali metals is reducer and, giving one electron, forms singly charged cation. It is more than common at Hydrogenous with halogens: Hydrogenous, as well as halogens nonmetal, its molecule it is biatomic, it can show oxidizing properties, forming with the fissile metals similar salts hydrides, for example, of NaH, CaH₂.

In the fourth period after Sc 10 transition elements (decade of Sc - Zn) are located behind which there are other 6 basic elements of the period (Ga - Kr). The fifth period is similarly constructed. The concept a transitional element is usually used for designation of any element with valence d- or f-electrons.

The sixth and seventh periods have double inserts of elements. Behind Ba element plug-in decade of d-elements (La - Hg), and after the first transition element of La follow 14 f-elements - lanthanides is located (Ce - Lu). After Hg other 6 main r-elements of the sixth period settle down (Tl - Rn).

In the seventh (incomplete) period for the next 14 f-elements-actinides follow (Th - Lr). Recently La and the next began to rank respectively as lanthanides and actinides. Lanthanides and actinides are placed separately in the bottom of the table.

Thus, each element in a periodic system holds strictly particular position which is noted serial, or atomic, by number [3].

In a periodic system eight groups are divided into subgroups (I-VIII) which in turn - main, or subgroups A and the secondary's, or B. Subgroups the VIII B-special are down located, it contains triads of the elements making families of iron (Fe, With, Ni) and platinum metals (Ru, Rh, Pd, Os, Ir, Pt).

Similarity of elements in each subgroup - the most noticeable and important regularity in a periodical system. In the main subgroups metallic from top to down amplify and nonmetallic weaken. At the same time there is an increase in stability of connections of elements in the lowest rate of oxidation for this subgroup. In the secondary subgroups - on the contrary - from top to down metallic weaken and stability of connections with the highest rate of oxidation increases.

Periodic system and electronic configurations of atoms

As at chemical reactions of a core of the reacting atoms do not change, chemical properties of atoms depend on a structure of their electronic shells.

Filling of electron layers and electronic shells of atoms happens according to a Pauli's exclusion principle and the rule Hunda.

Exclusion principle Pauli's (will lock Paulie)

Two electrons in atom can't have four identical quantum numbers (on each atomic orbital there can be no more than two electrons).

The Pauli's exclusion principle defines the maximal number of the electrons possessing this main quantum number of n (i.e. being on this electron layer): $N_n = 2n^2$. On the first electron layer (energy level) there can be no more than 2 electrons, on the second - 8, on the third - 18 etc.

In Hydrogenium atom, for example, there is one electron which is on the first energy level in $1s$ - a state. The spin of this electron can be directed randomly ($m_s = +1/2$ or $m_s = -1/2$). It is necessary to emphasize once again that the first energy level consists of one subtotal - $1s$, the second energy level - of two subtotals - $2s$ and $2p$, the third - of three subtotals - $3s$, $3p$, $3d$ etc. The subtotal, in turn, contains orbitals which number is defined by the secondariest quantum number l or equal $(2l + 1)$. Each orbital is conditionally designated by a cage, the electron which is on it - an arrow which direction indicates orientation of a spin of this electron. The arrangement of spins is defined by the rule Hunda which says: filling of energy levels happens so that the cooperative spin was maximal.

In atom each electron occupies the free orbital with the lowest energy answering to its greatest communication with a core. In 1961 M. Klechkovsky formulated the general provision according to which energy of electronic orbitals increases in an order of increase in the sum of the main and secondariest quantum numbers $(n + l)$, and in case of equality of these sums, smaller energy has the orbital with smaller value of the main quantum number of n [5, 7].

Determination of valency

It agrees according to polarity formulas, all elements VI A and VI B group have the electronic configurations finished on p^4 and d^{4-5} . Within the electronic theory the valency of atom is defined on the basis of number of unpaired electrons which participate in formation of electronic couples with electrons

of other atoms. Only the electrons which are on an external envelope of atom participate in formation of chemical bonds. Therefore the maximum valence of chemical element is a number of electrons in the external electronic shell of its atom. Proceeding from it, all elements VI A and VI B group show different valencies: II, III, IV, V, VI.

And in cases of these three elements their valence is defined by the phenomenon of "breakthrough". The phenomenon of "breakthrough" represents symbolical transferring of one of two valence s-electrons on a d-subtotal that reflects no uniformity of deduction by a core of outer-shell electrons.

Determination of ability to react an element with other elements, the reason of limitation of reaction of chemical elements VI A and VI B group

External level of atom is called the level, farthest from a core, at which still there are electrons. This envelope adjoins at collision with external levels of other atoms in chemical reactions. At interaction with other atoms oxygen is capable to accept the 2nd padding electron on the external level. At the same time atom oxygen will receive complete, that is as much as possible the filled external electronic level on which 6 electrons will settle down. And the reason of limitation of reaction of chemical elements is explained by it. Proceeding from it, the rule Gunda is similar and for all elements of this group.

Characteristics of chemical elements naturally change in groups and the periods [13].

As the chemical bond, an atom structure, electronic shells of atom influence properties of an element, ability to react an element depend on these factors too. For example, the molecule of oxygen consists of two atoms. The chemical bond is the covalent non-polar.

Oxygen is distinguished by high reactivity, it oxidizes many substances already at ambient temperature. Oxygen forms connections with all chemical elements, except helium, neon and argon. It interacts with the majority of elements immediately, except halogens, except for fluorine, gold and platinum.

Determination of ability to react an element with other elements, the reason of limitation of reaction of chemical elements of lantanoyd's

Лантаноиды – это 14 элементов, следующих за лантаном, у которых к электронной конфигурации лантана последовательно добавляются 14 4f-электронов.

Animation images of movements and work with them demands the large volume of memory. And for reduction of memory size, there is use of the virtual – interaktivization of processes, Flash is very efficient [14-17]. From the basic vektorno – the graphic Flash format of technologies Shorewave Flash (SWF) – a branch was created. But, it is not the first vector format, it is the Web broadcast mechanism – pages to SWF as finding of the graphic representation, the coordinating link of an instrumental inventory and the graphic representation. Advantage of SWF-of the application it is easily an acceptability on other Wednesday, i.e. this format is used in different is information – the program platform (in the Mac OS Macintosh operating system, in OS - Windows OS). One more feature of SWF – the constructed main images not only accept animation but also is padding, an opportunity to create interactive elements and audio of installation, and to form interactive virtual laboratory, very conveniently the formats SWF, CC of them – the program Flash environment. One more reason of popularity of SWF – a format this very mild and convenient application instruments for other platforms development of Macromedia. For example: creations of the multimedia presentations use the program device – Macromedia Director Shockwave Studio, - and are applied the program device to creation of graphic images – Macromedia Authorwave, Macromedia Course Builder. Therefore among Web – the publication the most recognizable and easily applied publication is Macromedia Flash Web – gives the chance to decorate each website with animation and to collect the complete page. Action Script Tools - allows to collect Web addition efficiently and its modern languages similarly probably on the scenario Java Script, Action Script and by means of the editor of Devigger is the solution of often applied elements. For virtualization and an interactivity of electronic orbitals, electronic configurations on each element of the table of Mendeleev Wednesday in a format CC – the program Flash and Web environment addition the scenario Java Script, Action Script and by means of the editor of Devigger is chosen computer program. On each element of the table of Mendeleev it was created an electronic configuration according to the law Gunda. By the rule Gunda when filling with electrons of orbitals, identical on energy, electrons settle down first of all on the single on each orbital, and a population of these orbitals begins only then the second electrons.

For example the polarity formula of oxygen bears very important information: the external electronic level of oxygen is filled with electrons not till the end (on it $4 + 2 = 6$ electrons) and before the complete filling there are not enough two electrons. The general view of the virtual and interactive table in the called program environment is given in the drawing-1. When pressing any button are automatically represented in movements - dynamics electronic configurations of any chemical element in flat-2D and volume - a 3D format and also the sequence of energy levels in ascending order of energy according to the following scheme:

$$1s < 2s < 2p < 3s < 3p < 4s \approx 3d < 4p < 5s \approx 4d < 5p < 6s \approx 5d \approx 4f < 6p.$$

We see atomic weight, valencies, quantity of neutrons, the Russian and English name and polarity formulas for I (A, B) groups of elements. And also for each chemical element I (A, B) groups are brought ordinal values and polarity formulas in the form of drawings. As it is specified in the drawing-1, the ordinal value of chemical element is atomic number. It is equal to quantity of protons. A symbol of a proton is Z. For definition of a neutron the formula is used:

$N = A - Z$ [9]. Preceding from a formula of energy levels the ability of chemical elements to chemical reactions or connections is also defined.

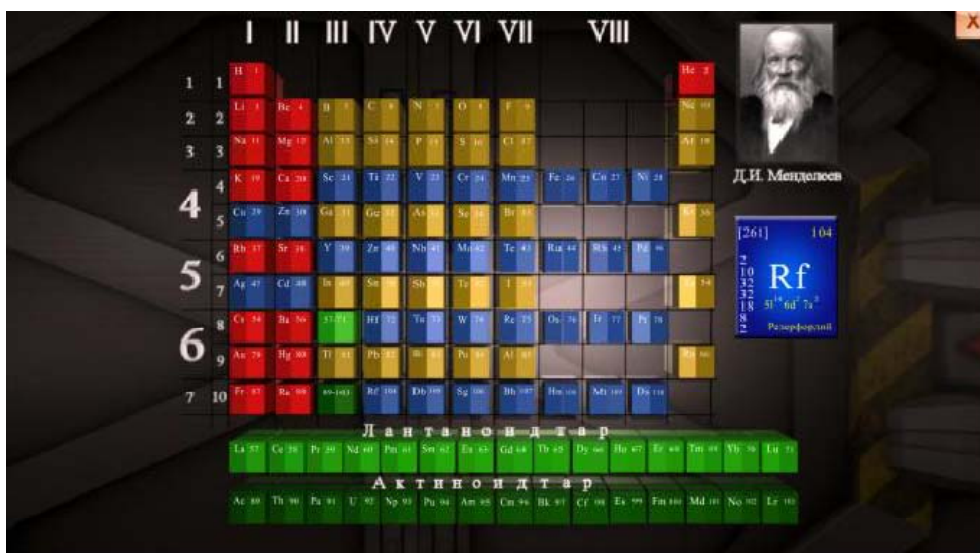

Picture 1 - Virtual and interactive periodic table chemical elements of D.I. Mendeleev



Picture 2 - Flat picture of electronic orbital's the Seaborgium element in driving, atomic weight, valence, quantity of neutrons and protons, polarity formula of energy levels of orbital's

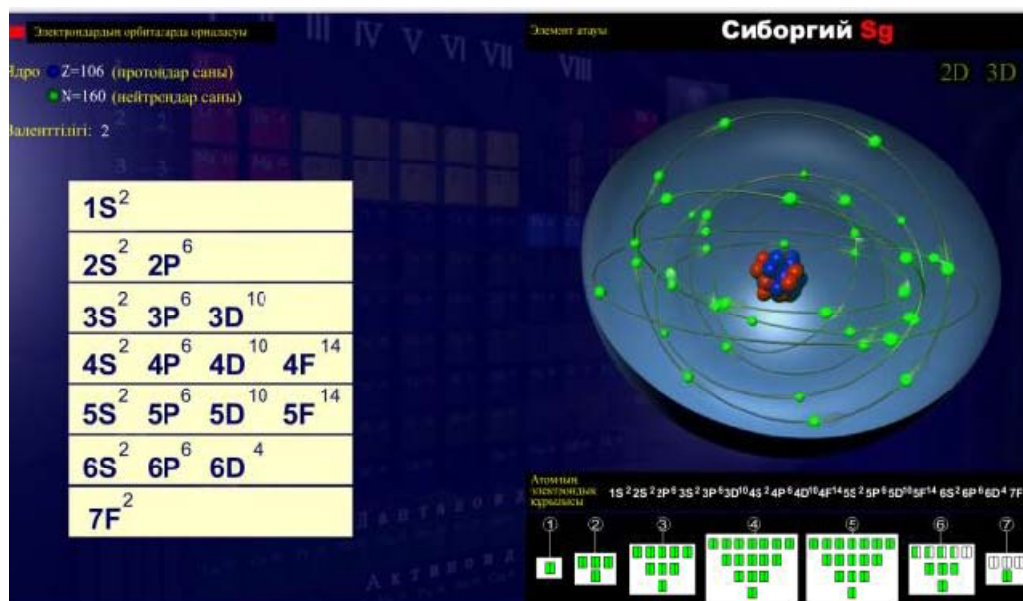

Picture 3 Volume picture of electronic orbital's The Seaborgium element in driving, atomic weight, valence, quantity of neutrons and protons, polarity formula of energy levels of orbital's

The virtual interactive-multimedia table of a periodic system of elements of D.I. Mendeleev on the electronic medium, apparently from this table is created, from a formula of energy levels and the ability of chemical elements to chemical reactions or to a chemical combination decides on other elements. On the basis of a research practical use of results of the virtual laboratory operated (interactive) with visualization and animation of mechanisms of course of processes, on inorganic and organic chemistry are planned. Will be applied to upgrading of tutoring, big saving of time (about 60% for assimilation of a subject), to self-contained carrying out research works, to development of creativity of students. The product will be used by all system of secondary education (schools, lyceums, gymnasiums), all system of the higher education where study chemistry, research institutes and laboratories and also food, chemical, pharmaceutical, other technological industries.

REFERENCES

- [1] Periodic law of chemical elements//Encyclopaedic dictionary by the young chemist. 2nd prod. / Сост. V.A. Kritsman, V.V. Stantso. M.: Pedagogics, **1990**. Page 185. ISBN 5-7155-0292-6.
- [2] [http://m.itest.kz/lekciya_neorganicheskaya_khimiya_nemetally_Nekrasov B. V.](http://m.itest.kz/lekciya_neorganicheskaya_khimiya_nemetally_Nekrasov_B.V.), Fundamentals of the common chemistry, t. 1, **1973**, page 29.
- [3] Remy G., Course of inorganic chemistry, t. 1, **1963**, page 29.
- [4] Messler R. W. The essence of materials for engineers. - Sudbury, MA: Jones& Bartlett Publishers, **2010**. P. 32.-ISBN 0763778338.
- [5] Agafoshin N. P. Periodic law and periodic system of elements of D.I. Mendeleev. M.: Education, **1973**. 208 pages.
- [6] Evdokimov Yu., To history of the periodic law. Science and life, No. 5 (**2009**), Page 12-15.
- [7] Makarenya A. A., Rysev Yu.V.D.I. Mendeleev. - M.: Education, 1983. 128 pages.
- [8] Makarenya A. A., Trifonov D. N. Periodic law of D.I. Mendeleev. M.: Education, **1969**. 160 pages.
- [9] Nekrasov B.V. Fundamentals of the common chemistry. - the 3rd prod. M.: Chemistry, **1973**. T. 1. 656 pages.
- [10] Remy G. Kurs of inorganic chemistry. - M.: Publishing house foreign liters, **1963**. T. 1. 920 pages.
- [11] Akhmetov N.S. Common inorganic chemistry. M: **2001**. 743p.
- [12] <http://www.alhimikov.net/elektronbuch/Page-6.html>
- [13] Adambek Tatenov, Akerke Shiynkulovna Amirkhanova, Victoria Viacheslavovna Savelyeva
- [14] Virtual-interactive visualization of atomic structures, electron configurations, energy levels in 3D format for the construction of virtual-interactive laboratories with the mechanisms of chemical reactions in inorganic and organic chemistry.- International Journal of Applied Engineering Research ISSN 0973-4562 Volume 11, Number 5 (2016) pp 3319-3321 © Research India Publications. <http://www.ripublication.com> 3319
- [15] Dronov V. Macromedia Flash MX. Express course; BHV-St. Petersburg. Moscow, **2003**. 344c.
- [16] Nikiforova N. G., Fedorovskaya R.A., Nikiforov A. V. Work in the environment of MacromediaFlash5; IVESEP-Moscow, 2008. 899 with.

[17] Tatenov A.M., Askarova Sh.M.n Virtual and Interactive Information Technology in Modeling Researches of Processes of Applied Problems of

[18] a Science. World Applied Sciences Journal,-30.(Management, Economics,

[19] Technology), 2014.pp.-144-148. ISSN.1818-4952.

УДК 542.8:544.14:539.19

А.М. Татенов, В.В. Савельева, А.С. Калиев

Евразийский технологический университет, г.Алматы, Казахстан

МЕХАНИЗМ СОЕДИНЕНИЯ ХИМИЧЕСКИХ ЭЛЕМЕНТОВ ТАБЛИЦЫ Д.И.МЕНДЕЛЕЕВА И ВИРТУАЛЬНАЯ ИНТЕРАКТИВИЗАЦИЯ В ПРОГРАММНОЙ СРЕДЕ FLASH-CC, JAVA SCRIPT

Аннотация. Ставится вопрос создания виртуальных интерактивных лаборатории с наглядностью глубинных механизмов химических реакций на атомарном уровне по неорганической химии.

На основе исследования планируются практические применения результатов виртуально-управляемой (интерактивная) лаборатории с визуализацией и анимацией механизмов протекания процессов, по неорганической и органической химии. Будут применяться для повышения качества обучения, большой экономии времени (около 60% на усвоение предмета), для самостоятельного проведения исследовательских работ, для развития творчества обучающихся. Продукт будут использовать вся система среднего образования (школы, лицеи, гимназии), вся система высшего образования где изучают химию, научно-исследовательские институты и лаборатории, а также пищевая, химическая, фармацевтическая, другие технологические индустрии.

Ключевые слова: периодическая система элементов, атом, электрон, протон, нейтрон, атомная масса, принцип Паули, правило Хунда, орбиталь, энергетические уровни, валентность,

УДК 542.8:544.14:539.19

А.М. Тәтенов, В.В. Савельева, А.С. Калиев

Еуразия технологиялық университеті, Алматы қ., Қазақстан

Д.И.МЕНДЕЛЕЕВ ТАБЛИЦАСЫНДАҒЫ ХИМИЯЛЫҚ ЭЛЕМЕНТТЕРДІҢ ҚОСЫЛУ МЕХАНИЗМДЕРІН FLASH-CC, JAVA SCRIPT-БАҒДАРЛАМАЛЫҚ ОРТАЛАРЫНДА ВИРТУАЛДАП-ИНТЕРАКТИВТЕНДІРУ

Аннотация. Органикалық емес химиядан химиялық реакциялардың тереңдетілген механизмін көрнекілеу мақсатында виртуалды-интерактивті зертханалар жасауды сұрақ ретінде мақалада қойып отыр.

Осы зерттеулер нәтижесінде, органикалық және органикалық емес химиядан жасалған виртуалды-интерактивті зертханалар көмегімен көрнекіленген және анимацияланған реакция процесстерінің механизмін тәжірибе жүзінде қолданысқа жіберу көзделіп отыр. Бұндай қолданыс оқу сапасын арттыру мақсатында, оқу уақытын үнемдеуге (пәндерді меңгеруге кететін уақытты -60%-ға дейін), өз бетімен зерттеу жұмыстарын жүргізуге, оқушылардың шығармашылық қабілетін арттыруға көмектеседі. Жоба нәтижесін барлық білім салалары қолданады; мектептер, лицейлер, гимназиялар, химияны оқитын барлық жоғары білім жүйесі, ғылыми-зерттеу институттары, зертханалары, фармацевтика, химия, тамақ индустриялары.

Түйін сөздер: элементтердің периодтық жүйесі, атом, электрон, протон, нейтрон, атомдық масса, Паули принципі, Хунд ережесі, орбиталь, энергетикалық деңгейлер, валенттілік.

NEWS

OF THE NATIONAL ACADEMY OF SCIENCES OF THE REPUBLIC OF KAZAKHSTAN

SERIES CHEMISTRY AND TECHNOLOGY

ISSN 2224-5286

Volume 3, Number 429 (2018), 61 – 66

UDC 661.634

Zh.M. Altybayev¹, Sh.K. Shapalov¹, A.E. Bitemirova¹, Zh.K. Dzhanmuldaeva²,
M.Zh. Aitureyev², G.S. Kenzhibayeva², A.Zh. Suygenbayeva², G.M. Iztileuov²

¹South Kazakhstan Pedagogical University, Shymkent, Kazakhstan;

²M.Auezov South Kazakhstan State University, Shymkent, Kazakhstan

E-mail.ru: arsenal_575@inbox.ru, shermahan_1984@mail.ru, bitemirova1960@mail.ru, zhanyld@mail.ru,
murattssm@mail.ru.

THERMODYNAMIC RESEARCH OF THE POSSIBILITY OF PHOSPHATIC AND SILICEOUS FINES SINTERING WITH THE FLUXING ADDITIVES

Annotation. The research of thermodynamic possibility of the most possible reactions course in the sintering process of phosphatic and siliceous fines in the presence of fluxed additives is conducted. Sub-standard nickel-cobalt ores and internal overburdens are used as fluxed additives.

It is established that for course of reaction of Ni and Co containing components it is necessary to increase the temperature due to the presence of carbon in internal overburdens and a coke fines. It is revealed that presence of fluxing additives in sintering charge 10% to phosphorite weight in some provided chemical reactions given in article decreases the melting temperature on 3230 K – 3730 K and makes favorable impact on structure of the received sinter, increasing his strength characteristics by 10-15%.

Keywords: thermodynamic research, Gibbs energy, temperature, possible reactions, fluxed sinter, fluxing additives.

Introduction. Production of the elemental yellow phosphorus, which is the main raw material for manufacture of feed phosphates, many mineral acids, various grades of salts, detergents and other products, relates with the reduction of natural phosphates in the round and closed ore-thermal furnaces of the ORC type.

In the process of mining and preparation of commercial phosphorites to the electro thermal sublimation a significant amount of ore fines is formed. The total amount of sub-standard fines, formed at the preparation of raw materials for the yellow phosphorus production, is 55-60% of the mined ore mass [1,2] depending on the geological structure of various sections of a phosphorite deposit, their mechanical properties and composition.

Phosphorus industrial enterprises, designed for the lump phosphate processing, recycle only a small amount of phosphate fines. But the above-mentioned fines of 0-5 mm class, formed during the mining and preparation of lump phosphate raw material, transportation for the technological processing, do not provide a favorable and uniform gas-dynamic mode and exit of gases from the furnace bath at the insignificant hydrodynamic resistance in the phosphoric furnace.

In addition, in conditions of the forced industrial-innovative development of the country there is a question of the complex and rational use of industrial wastes of various industries which allow to decrease a consumption of material and energy resources at the yellow phosphorus production [3-5].

Based on the foregoing, the use of fines of phosphate raw material mined on the Karatau field deposits in the electrothermics of phosphorus is the basic economic and environmental problem. The solution of this problem is connected with the improvement of existing methods of thermal preparation of

a raw charge and the development of new processes and devices for the preparation and processing of phosphate rock in the phosphorus production.

Methods of the research. The researches are conducted by the full thermodynamic analysis with use of the program HSC-5.1 complex Finnish metallurgical the Outokumpu [6] companies, the minimum of energy of Gibbs [6] based on the fundamental principle taking into account that

$$G(x) = \sum_{a=1}^f \cdot \sum_{j=1}^{ia} X_j \left(C_j + \ln \left(\frac{X_j}{X_a} \right) + \ln \gamma_j \right) \rightarrow G(x) \min \quad (1)$$

at restrictions in a look:

$$\left. \begin{aligned} \sum_{j=1}^m a_{ij} X_j &= b_i \\ \sum_{j=1}^m X_j &= X_a \end{aligned} \right\} \quad (2)$$

where f – the total number of phases of system; b_i – the total number of moths of an independent component i in system; C_j – empirical thermodynamic function; X_a – the total number of moths of a phase and in system; X_j/X_a – a molar share of dependent j -of a component in a phase and.

At carrying out of given researches the subprogrammes as "Reaction Equations", "Equilibrium compositions" were used.

Experimental part. We have offered a way of siting of phosphatic raw materials [6, 7] which allows to receive fluxed phosphoric sinter with high technological properties.

For the research carrying out we developed and installed a laboratory plant, including a sintering bowl for the phosphate fines siting, which is shown in figure 1 [8].

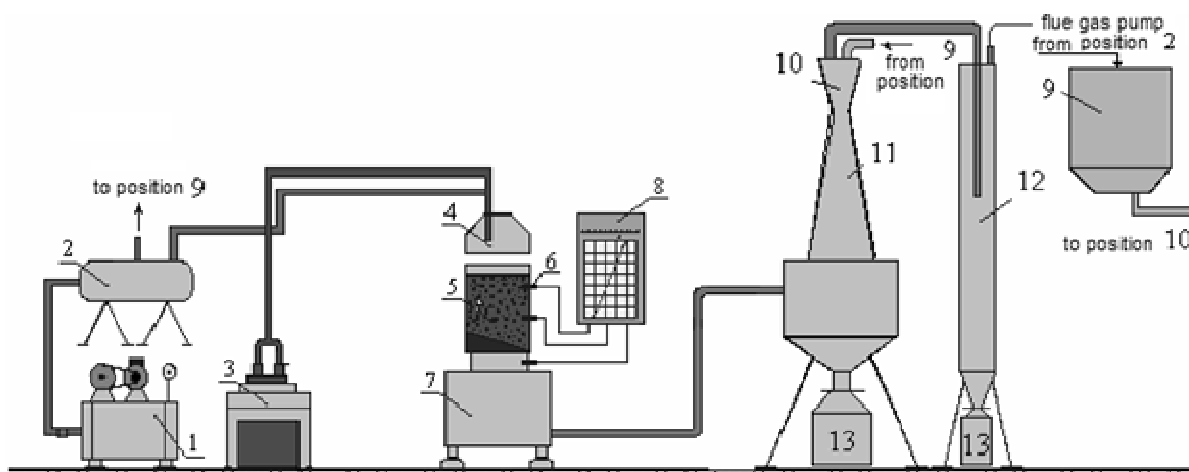

1 - compressor, 2 - spreader, 3 - fuel unit, 4 - ignition furnace, 5 - sintering cylinder, 6 - thermocouple, 7 - vacuum gage, - coordinate recording potentiometer, 9 - water storage, 10 - Venturi tube; 11 - scrubber, 12 - spray catcher, 13 - receiver for sludge.

Figure 1 - Laboratory plant for production of fluxed phosphate sinter

The laboratory plant has a system of temperature and pressure control at work of the sinter bowl.

In the sintering process the off-grade nickel-cobalt-containing ore (NCO) and the internal overburden (IO) - waste of the coal mining industry – are used as an fluxing agent and an additional fuel [9-15].

Addition to the charge up to 10% of the internal overburden and the nickel-cobalt ore permit to decrease a consumption of the solid fuel (coke) on 15-20%, to receive more durable sinter and at the further synthesis of phosphorus from the fluxed sinter to produce the alloyed with valuable elements ferroalloy.

These effects are achieved at the expense of:

- content of free carbon up to 50% in the internal overburden;
- obtaining of the eutectic liquid phase in the sintered material layer on 10-12% (relatively) higher than at the existing technology due to the content of fusible minerals in NCO and IO.

For this problem solving we made the sampling of internal overburden formed at the brown coal mining of the Lenger deposit (Kazakhstan, South Kazakhstan Region) and the nickel-cobalt-containing off-grade ore of the Kempirsay deposit (Kazakhstan, Aktobe region) and also we carried out a research of the sintering process of the Zhanatas deposit phosphorite fines in combination with the above additives.

The chemical composition of the charge materials (in %):

- the internal overburden of Lenger brown coal deposit: Cr₂O₃ – up to 0.1; Fe₂O₃ – 2.6-11.9; Al₂O₃ – 6.5-9.5; SiO₂ – 48-52; CaO – 0.5-2.5; MgO – 0.9-2.9; C_{free} – 25-35; K₂O – 0.4-0.7; Na₂O – 0.3-0.5; etc. up to 100;

- nickel-cobalt-containing ores: NiO – 0.88; CoO – 0.05; Cr₂O₃ – 1.4; Fe₂O₃ – 20.4; Al₂O₃ – 6.4; SiO₂ – 31.6; CaO – 0.6; MgO – 6; C_{free} – 1.1;

- phosphorites of the Zhanatas deposit: P₂O₅ – 21.2; SiO₂ – 24.1; CaO – 36.8; MgO – 2.1; Al₂O₃ – 1.6; Fe₂O₃ – 1.7.

For the sintering process carrying out we used a charge mixture taken in defined ratio with the following composition: phosphate raw material – 55.0-67.0 % with a size 3-10 mm; sinter fines return – 14-16 % with a particle size 0-5 mm, nickel-cobalt ore – 3-17 % with a size 0-5 mm, internal overburden – 3-17 % with a size 0-5 mm; solid fuel (coke breeze) – 3-5 % with a size 0-3mm. The charge is mixed, moistened up to moisture content 6-8 %, pelletized and loaded on a fire grate of the sinter bowl with a height of a layer 200-220 mm over the 10-20 mm “bed” layer from the sinter with a fraction 8-16 mm. Then the fuel contained in the charge is ignited by the blowing of a gas heat carrier, formed at the combustion of natural gas in a burner.

Sintering of an agloshikhta is conducted during 35-45 minutes at preservation of the module of acidity of the offlyusovanny phosphoritic sinter equal 0,93-1,16.

Increase in durability in the course of high-temperature roasting, according to us, happens due to education in system “liquid - firm” the aluminosilikatnykh and phosphorite-nickel-cobalt of calcic connections which when cooling harden, creating the difficult destroyed sheaves between larger melted-off particles of a phosphatic and siliceous fines.

The thermodynamic possibility of course of the main reactions of solid-phase interaction between components of furnace charge was estimated with use of the program complex based on the fundamental principle of a minimum of energy of Gibbs by calculation and definition of Change of energy of Gibbs for a number of chemical compounds in the range of temperatures 673-1873 °K.

Calculation in the studied system was carried out only for most for the most possible interactions given below:

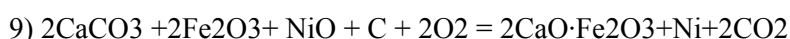
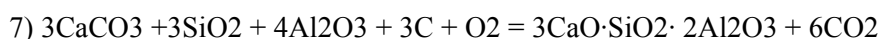
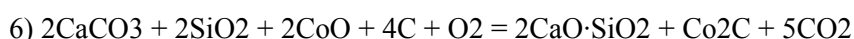
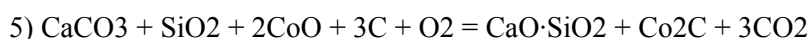
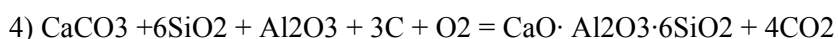
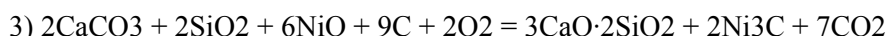
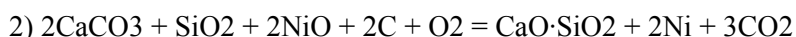
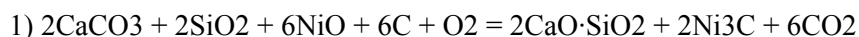

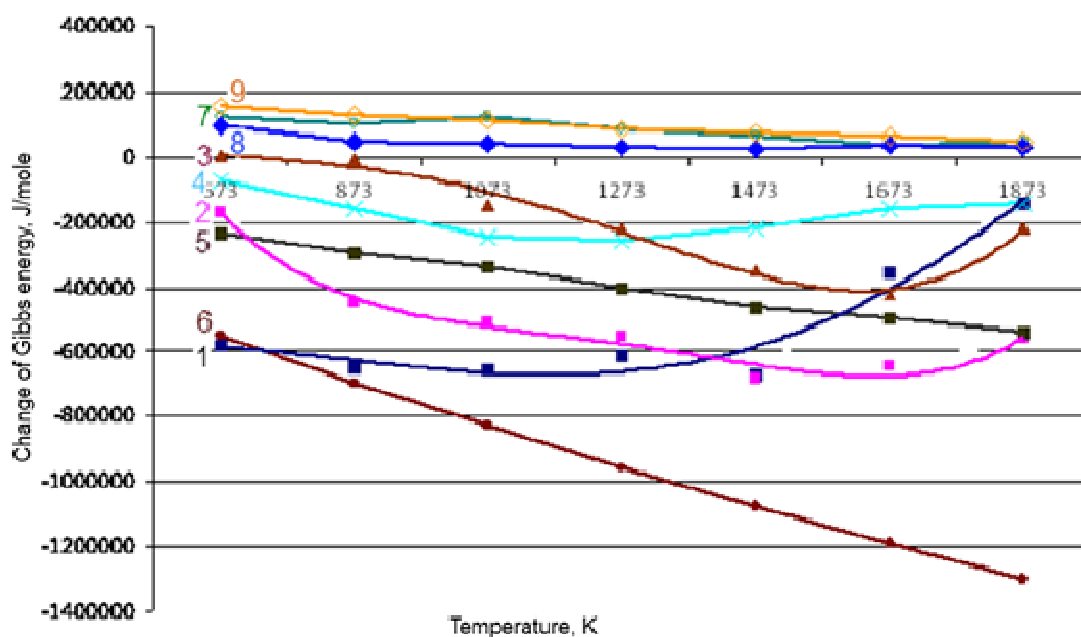

Changes of energy of Gibbs of reaction at course of reaction given above are given in the figure 2.
Figure 2 - Results of calculations of change of Gibbs energy at course of reaction on the equations (1) – (9)

It agrees the change of Gibbs energy of reactions (1) – (9) presented in the figure 2 of solid-phase interactions in the oxidizing and deoxidizing environment it is possible to assume the following:

- reactions of interaction (7) - (9) between components of charge mix in the field of the studied temperatures are theoretically impossible as in all interval of the studied temperatures of value of Gibbs energy is ;

- reactions of interaction (1) - (4) between components of charge mix with formation of metal nickel, nickel carbide Ni_3C and also silicates $2CaO \cdot SiO_2$, $CaO \cdot SiO_2$, $2CaO \cdot Al_2O_3 \cdot 6SiO_2$ in the field of the studied temperatures (673-18730 K) thermodynamic are possible because ;

- reactions of solid-phase interaction (3) with formation of silicate of calcium $3CaO \cdot 2SiO_2$ and nickel carbide Ni_3C in the range of temperatures 673-18730 K thermodynamic are possible;

- reactions of solid-phase interaction (5) and (6) with formation of silicates of calcium $CaO \cdot SiO_2$, $2CaO \cdot SiO_2$ and cobalt carbide Co_2C in the range of temperatures 673-18730 K thermodynamic are possible.

Conclusions:

It is revealed that in the conditions of sintering process the heating of charge materials to the maximum temperatures of a zone of fuel burning is carried out for very short time. At the same time the practical value has the interaction between solid phases in an initial stage. Presence at composition of furnace charge of sintering process nickel-cobalt ore and internal overburden breeds of coal mining in number of 10% to the phosphorite weight on the equations (1) – (7) reduces melting temperature on 323-3730 K and makes favorable impact on structure of the received sinter, increasing its strength characteristics on 10-15%.

REFERENCES

- [1] Zhantsov K.T., Bishimbayev V.K., Alteev T., Zhantsov M.K., Protopopov A.V. Integrated thermochemical processing industrial waste and the energy-fuel resources. (rus) // Proceedings of the All Russian Scientific Technical Conference with international participation "Electermia - 2006", St. Petersburg, **2006**. P. 275-279.
- [2] Korshunov V. On the directions of research on the use of the poor in the production of phosphate rock fertilizers (rus). Bulletin of NIUIF "Mir Sery, N, P, K», no. 5, **2003**. P. 5-9.
- [3] Alteev T.K. To the problem of complex and rational utilization of waste of industries. (rus) // Materials of International Scientific-Practical Conference "Regional problems of ecology and life safety", Almaty, **2002** Part 1. P. 145-147.

- [4] Zhantsov M.K., Serzhanov G.M., Bishimbayev V.K., Zhantsov K.T., Ananiev N.I., Altybayev Zh.M. Utilization of industrial waste in the production of phosphorus. Proceedings of the 4th International Forum (9th International Conference). Samara, **2008**. P. 41-45.
- [5] Zhantsov K.T., Altybayev Zh.M. Researches on an intensification of phosphoric production. Collection of scientific works of graduate students, undergraduates, trainees-researchers. M. Auyezov SKSU, **2009**, No. 10. P. 211-214.
- [6] Roine A. Outokumpu HSC Chemistry for Windows. Chemical Reaction and Equilibrium software with Extensive Thermochemical Database. Pori: Outokumpu Research OY, **2002**.
- [7] Udalov Yu.P. Application of program complexes of computing and geometrical thermodynamics in design of technological processes of inorganic substances. SPb.: SPbSTI(TU), **2012**. 187 p.
- [8] Innovative patent of Republic of Kazakhstan #18523. Method of sintering of phosphate-siliceous fines. / Bishimbayev V.K., Zhantsov K.T., Ananiev N.I., Moldabekov Sh.M., Frangulidi L.H., Barlybaev M.R., Zhantsov M.K., Zhilkibaev M.A., Altybayev Zh.M.; published 15.06.2007, bulletin #6, **2007**.
- [9] Bishimbayev V.K., Zhantsov K.T., Zhantsov M.K., Lavrov B.A., Altybayev Zh.M., Frangulidi L.H., Eskendirova M.M. Improvement of sintering method in production of yellow phosphorus. News of the St. Petersburg state institute of technology. St. Petersburg, **2012**. P. 29-30.
- [10] Petropavlovski I.A., Pochitalkina I.A., Zhantsov K.T., Altybayev Zh.M., Zhantsov M.K., Lavrov B.A., Frangulidi L.H. Receiving of phosphoric fluxed sinter with the improved technological properties for phosphorus production. // "Chemical industry today". **2013**. No. 1. P. 7-9.
- [11] Frangulidi L.H., Zhantsov M.K., Altybayev Zh.M., Bazhirova K.N., Eskendirova M.M. The research of fluxed sinter production with sufficiently high strength and improved technological properties. // "Eurasian chemico-technological journal". **2012**. #4. P. 351-355.
- [12] Altybayev Zh.M., Zhantsov K.T., Altybayev M.A. Researches on receiving fluxed sinter with the improved strength indicators. Materials for the IX ISPC "Real Researches and Development-2013". 17-25 January, **2013**. Sofia. 90-92 p.
- [13] Zhantsov K.T., Altybayev Zh.M., Zhantsov M.K. Use non-oxidized ore nickel-kobaltsoderzhashchey for receiving the fluxed phosphoric sinter. Works of ISPC "Auyezov's Readings-10": "20th summer boundary: The innovative directions of development of science and education" – Shymkent, **2011**. t.5, P. 25-28
- [14] Zhantsov K.T., Frangulidi L.H., Zhantsov M.K., Altybayev Zh.M. Researches on receiving fluxed sinter with the improved strength indicators. Science and education of Kazakhstan. No. 2, **2011** of (88). P. 90-93.
- [15] Lavrov B.A., Zhantsov K.T., Altybayev Zh.M., Frangulidi L.H., Zhantsov of M.K. Study of sintering process of a phosphoric fines with the fluxed additives creating the exothermic and strengthening effect. Scientific magazine "Electrometallurgy". Moscow, No. 4, **2012** of – p. 16-19.

**Ж.М. Алтыбаев¹, Ш.К. Шапалов¹, А.Е. Битемирова^{1,2}, Ж.К. Джанмулдаева²,
М.Ж. Айтуреев², Г.С. Кенжибаева², А.Ж. Суйгенбаева², Г. Изтилеуов²**

¹Оңтүстік Қазақстан педагогикалық университеті, Шымкент, Қазақстан

²М.Әуезов атындағы Оңтүстік Қазақстан мемлекеттік университеті, Шымкент, Қазақстан

ФОСФАТТЫ-КРЕМНИЙЛІ ҰСАҚТЫ ФЛЮСТЕУШІ ҚОСПАЛАРМЕН АГЛОМЕРАЦИЯЛАУ МҮМКІНДІГІН ТЕРМОДИНАМИКАЛЫҚ ЗЕРТТЕУ

Аннотация. Фосфатты-кремнийлі ұсақты флюстеуші қоспалардың қатысуымен агломерациялау үрдісінде мүмкіндігі аса жоғары реакциялардың жүруінің термодинамикалық мүмкіндігі зерттелді. Флюстеуші қоспалар ретінде кондициялы емес никель-кобальт құрамды кен мен ішкі қазба жыныстыр пайдаланылды.

Ni және Co құрамды компоненттер реакциясының жүруі үшін ішкі қазба жыныстары мен кокс ұсағы құрамындағы көміртектің жануы есебінен температураны көтеру керектігі анықталды. Агломерациялы шихтаның құрамында флюстеуші қоспалардың фосфориттің салмағына қатысты 10 % мөлшерде болуы мақалада келтірілген кейбір реакциялардың балқу температурасын 3230 К – 3730 К азайтады және оның беріктік қасиетін 10-15%-ға жоғарылата отырып алынатын агломераттың құрылысына қолайлы әсер етеді.

Түйін сөздер: термодинамикалық зерттеу, Гиббс энергиясы, температура, болжамды реакциялар, флюстенген агломерат, флюстеуші қоспалар.

Ж.М. Алтыбаев¹, Ш.К. Шапалов¹, А.Е. Битемирова^{1,2}, Ж.К. Джанмулдаева²,
М.Ж. Айтуреев², Г.С. Кенжибаева², А.Ж. Суйгенбаева², Г. Изтилеуов²

¹Южно-Казахстанский педагогический университет, Шымкент, Казахстан;

²Южно-Казахстанский государственный университет им. М.Ауэзова, Шымкент, Казахстан

ТЕРМОДИНАМИЧЕСКОЕ ИССЛЕДОВАНИЕ ВОЗМОЖНОСТИ АГЛОМЕРАЦИИ ФОСФАТНО-КРЕМНИСТОЙ МЕЛОЧИ С ФЛЮСУЮЩИМИ ДОБАВКАМИ

Аннотация. Проведено исследование термодинамической вероятности протекания наиболее возможных реакций в процессе агломерации фосфатно-кремнистой мелочи в присутствии флюсующих добавок. В качестве флюсующих добавок использовались некондиционные никель-кобальтсодержащие руды и внутренних вскрышных породы угледобычи бурых углей.

Установлено, что для протекания реакции компонентов содержащих Ni и Co необходимо поднять температуру за счет сгорания углерода в внутренних вскрышных пород и мелочи кокса. Выявлено, что присутствие в составе агломерационной шихты флюсующих добавок 10% к весу фосфорита в некоторых приведенных в статье химических реакции снижает температуру плавления на 3230 К – 3730 К и оказывает благоприятное воздействие на структуру получаемого агломерата, увеличивая его прочностные характеристики на 10-15%.

Ключевые слова: термодинамическое исследование, энергия Гиббса, температура, вероятные реакции, флюсованный агломерат, флюсующие добавки

Information about authors:

Altybayev Zh.M. - PhD, Senior teacher, Department of chemistry and biology, South Kazakhstan Pedagogical University, Shymkent, Kazakhstan;

Shapalov Sh.K. - PhD, Senior teacher, Department of chemistry and biology, South Kazakhstan Pedagogical University, Shymkent, Kazakhstan;

Bitemirova A.E. - candidate of chemical Sciences, Associated Professor, Department of chemistry and biology, South Kazakhstan Pedagogical University, Shymkent, Kazakhstan;

Dzhanmuldaeva Zh.K. – candidate of technical Sciences, Professor, Department “Chemical technology of inorganic substances”, M.Auezov South Kazakhstan State University, Shymkent, Kazakhstan;

Aituryev M.Zh.- candidate of chemical Sciences, Associated Professor, Department «Technology of cement, ceramic and glass», South Kazakhstan Pedagogical University, Shymkent, Kazakhstan;

Kenzhibayeva G.S. - candidate of technical Sciences, Associated Professor, Department “Chemical technology of inorganic substances”, M.Auezov South Kazakhstan State University, Shymkent, Kazakhstan;

Suigenbayeva A.Zh. - candidate of technical Sciences, Associated Professor, Department “Chemistry”, M.Auezov South Kazakhstan State University, Shymkent, Kazakhstan;

Iztleuov G.M. - candidate of chemical Sciences, Associated Professor, Department “Ecology”, M.Auezov South Kazakhstan State University, Shymkent, Kazakhstan.

NEWS

OF THE NATIONAL ACADEMY OF SCIENCES OF THE REPUBLIC OF KAZAKHSTAN

SERIES CHEMISTRY AND TECHNOLOGY

ISSN 2224-5286

Volume 3, Number 429 (2018), 67 – 72

Sh.B. Kasenova¹, B.K. Kasenov¹, Zh.I. Sagintaeva¹,
M.O. Turtubaeva², E.E. Kuanyshbekov¹

¹ Chemical-metallurgy institute named after Zh. Abishev, Karaganda, Kazakhstan;

² Pavlodar State University. S.Toraigyrova, Pavlodar, Kazakhstan

kasenov1946@mail.ru

NEW NANO-SIZED (NANOCLUSTER) COBALT- CUPRATE - MANGANITES OF LANTHANE AND ALKALINE METALS AND THEIR X-RAY DIFFRACTION STUDY

Abstract. The search for new combined manganese, copper and cobalt-containing nanomaterials and the study of their properties *is quite interesting* for inorganic materials science, especially for microelectronics. Interest in such compounds is due to the polyfunctionality of the demonstrated properties and the flexibility of the composition, allowing many elements of the periodic system to be adopted.

Cobalt-cuprate-manganites of the composition $\text{LaMe}^1_2\text{CoCuMnO}_6$ ($\text{Me}^1 - \text{Li, Na, K}$) were synthesized by ceramic technology of lanthanum oxide (III), cobalt oxide(II), copper oxide (II), carbonates of manganese (III), lithium, sodium and potassium in the interval 800-1200 °C. After every 100 °C the formulations were cooled, rubbed and reheated. To obtain equilibrium phases at low temperatures, low-temperature annealing was carried out at 400 °C for 10 hours. Their nanoscale (nanoclusters) particles were obtained by grinding on a vibrational mill from Retsch (Germany) of the brand "MM301". The dimensions were determined on an electronic microscope JSPM-5400 Scanning Probe Microscope "JEOL" (Japan). Prepared nanoparticles (nanoclusters) compounds of the size of 40-90 nm. X-ray phase analysis of new compounds was carried out on a DRON-2.0 unit. The analytical method of X-ray indications is established that the synthesized nanoscale new phases are crystallize in cubic syngony with the following lattice parameters: $\text{LaLi}_2\text{CoCuMnO}_6 - a=11,33\pm 0,02 \text{ \AA}; V^0=2563,20\pm 0,06 \text{ \AA}^3; Z=4; V^0_{\text{el.cell}}=640,80\pm 0,02 \text{ \AA}^3; \rho_{\text{X-ray}} = 4,0 \text{ g/cm}^3$; $\text{LaNa}_2\text{CoCuMnO}_6 - a=14,43\pm 0,02 \text{ \AA}; V^0=3005,5\pm 0,07 \text{ \AA}^3; Z=4; V^0_{\text{el.cell}}=751,38\pm 0,02 \text{ \AA}^3; \rho_{\text{X-ray}} = 3,86 \text{ g/cm}^3$; $\text{LaK}_2\text{CoCuMnO}_6 - a=14,90\pm 0,02 \text{ \AA}; V^0=3306,90\pm 0,06 \text{ \AA}^3; Z=4; V^0_{\text{el.cell}}=826,52\pm 0,02 \text{ \AA}^3; \rho_{\text{X-ray}} = 3,68 \text{ g/cm}^3$. Based on X-ray phase analysis, it can be assumed that the nanoscale cobalt-cuprate-manganites obtained are related to the space group $Pm\bar{3}m$.

Key words: cobalt, cuprate, manganite, lanthanum, alkali metals, synthesis, nanoparticles, radiography.

УДК 546.05+548.3+54-31+546.732:562:713:654:31

Ш.Б. Касенова¹, Б.К. Касенов¹, Ж.И. Сагинтаева¹,
М.О. Туртубаева², Е.Е. Куанышбеков¹

¹ Химико-металлургический институт им. Ж.Абишева, Караганда, Казахстан;

² Павлодарский государственный университет им. С.Торайгырова, Павлодар, Казахстан

НОВЫЕ НАНОРАЗМЕРНЫЕ (НАНОКЛАСТЕРНЫЕ) КОБАЛЬТО- КУПРАТО-МАНГАНИТЫ ЛАНТАНА И ЩЕЛОЧНЫХ МЕТАЛЛОВ И ИХ РЕНТГЕНОГРАФИЧЕСКОЕ ИССЛЕДОВАНИЕ

Аннотация. Поиск новых совмещенных марганец, медь и кобальтсодержащих наноматериалов и изучение их свойств представляет определенный интерес для неорганического материаловедения, особенно для микроэлектроники. Интерес к подобным соединениям обусловлен полифункциональностью демонстри-

руемых свойств и гибкостью состава, позволяющий принимать многие элементы периодической системы. По керамической технологии из оксидов лантана (III), кобальта (II), меди (II), марганца (III) и карбонатов лития, натрия и калия в интервале 800-1200 °С синтезированы кобальто-купрато-манганиты состава $[\text{LaMe}^1_2\text{CoCuMnO}_6$ ($\text{Me}^1 - \text{Li, Na, K}$). Через каждые 100 °С составы охлаждались, перетирались и заново нагревались. Для получения равновесных фаз при низких температурах проводили низкотемпературный отжиг при 400 °С в течение 10 часов. Измельчением их на вибрационной мельнице компании Retsch (Германия) марки «ММ301» получили их наноразмерные (нанокластерные) частицы, размеры которых определены на электронном микроскопе JSPM-5400 Scanning Probe Microscope «JEOL» (Япония). Получены наночастицы (нанокластеры) соединений размером 40-90 нм. Рентгенофазовый анализ новых соединений проводили на установке ДРОН-2,0. Аналитическим методом индирования рентгенограмм установлено, что синтезированные наноразмерные новые фазы кристаллизуются в кубической сингонии со следующими параметрами решетки: $\text{LaLi}_2\text{CoCuMnO}_6 - a=11,33\pm 0,02 \text{ \AA}$; $V^0=2563,20\pm 0,06 \text{ \AA}^3$; $Z=4$; $V^0_{\text{эл.яч.}}=640,80\pm 0,02 \text{ \AA}^3$; $\rho_{\text{рент.}} = 4,0 \text{ г/см}^3$; $\text{LaNa}_2\text{CoCuMnO}_6 - a=14,43\pm 0,02 \text{ \AA}$; $V^0=3005,5\pm 0,07 \text{ \AA}^3$; $Z=4$; $V^0_{\text{эл.яч.}}=751,38\pm 0,02 \text{ \AA}^3$; $\rho_{\text{рент.}} = 3,86 \text{ г/см}^3$; $\text{LaK}_2\text{CoCuMnO}_6 - a=14,90\pm 0,02 \text{ \AA}$; $V^0=3306,90\pm 0,06 \text{ \AA}^3$; $Z=4$; $V^0_{\text{эл.яч.}}=826,52\pm 0,02 \text{ \AA}^3$; $\rho_{\text{рент.}} = 3,68 \text{ г/см}^3$. На основании рентгенофазового анализа можно предположить, что полученные наноразмерные кобальто-купрато-манганиты относятся к пространственной группе *Pm3m*.

Ключевые слова: кобальт, купрат, манганит, лантан, щелочные металлы, синтез, наночастицы, рентгенография.

Введение. Купраты, манганиты, кобальтиты, никелиты редкоземельных элементов, допированных легкими оксидами щелочных и щелочноземельных металлов обладают уникальными физическими и физико-химическими свойствами, как сверхпроводниковыми, полупроводниковыми, а также представляют интерес как материалы, имеющие гигантские (колоссальные) значения магнетосопротивления, диэлектрической проницаемости, что очень важно для микроэлектроники в качестве веществ с высокой оперативной памятью [1-16].

В Химико-металлургическом институте им. Ж.Абишева в течение ряда лет проводятся целенаправленные исследования по синтезу и изучению физико-химических свойств двойных и тройных манганитов, хромитов, ферритов, цинкато-манганитов, результаты которых обобщены в монографиях [17, 18].

Определенный научный и практический интерес представляет получение перовскитоподобных соединений, где кобальтиты, купраты и манганиты представлены в виде единой фазы, как кобальто-купрато-манганиты.

С этой целью в данной работе представлены результаты синтеза и рентгенографического исследования новых наноразмерных (нанокластерных) кобальто-купрато-манганитов состава $\text{LaMe}^1_2\text{CoCuMnO}_6$, где $\text{Me}^1 - \text{Li, Na, K}$.

Методы. Керамическая технология, рентгенофазовый анализ, электронная микроскопия.

Результаты исследований. Исходными реагентами для синтеза использовались La_2O_3 (марки «ос.ч.»), Li_2CO_3 , Na_2CO_3 , K_2CO_3 , CoO , CuO , Mn_2O_3 квалификации «ч.д.а». Твердофазный синтез проводили взаимодействием вышеуказанных веществ при 800-1200°С в течение 20 часов с периодическим охлаждением и перетиранием смесей через 100°С. Низкотемпературный отжиг смесей проводили при 400°С в течение 10 часов.

Наноразмерные частицы синтезированных кобальто-купрато-манганитов синтезированных кобальто-купрато-манганитов получали измельчением на вибрационной мельнице компании Retsch (Германия) марки «ММ301». Размеры измельченных частиц устанавливали на электронном микроскопе JSPM-5400 Scanning Probe Microscope «JEOL» (Япония). Получены наночастицы (нанокластеры) от 40 до 90 нм. Ниже на рисунке приведены их электронно-микроскопические снимки.



Рисунок – Электронная микроскопия $\text{LaLi}_2\text{CoCuMnO}_6$ (а), $\text{LaNa}_2\text{CoCuMnO}_6$ (б), $\text{LaK}_2\text{CoCuMnO}_6$ (в)

Рентгенофазовый анализ образовавшихся нанофаз проводили на установке ДРОН 2,0. Условия съемки: CuK_α – излучение, Ni – фильтр, $U = 30$ кВ, $I = 10$ мА, скорость вращения счетчика 2 оборота в минуту, диапазон шкалы 1000 импульсов в секунду, постоянная времени $\tau = 5$ с, интервал углов 2θ от 10 до 90 градусов. Интенсивность дифракционных максимумов оценивали по стобалльной шкале. Индексирование рентгенограмм полученных соединений проводили аналитическим методом [19].

Ниже в таблице приведены результаты индексирования рентгенограмм синтезированных соединений.

Таблица – Индексирование рентгенограмм кобальто-купрато-манганитов

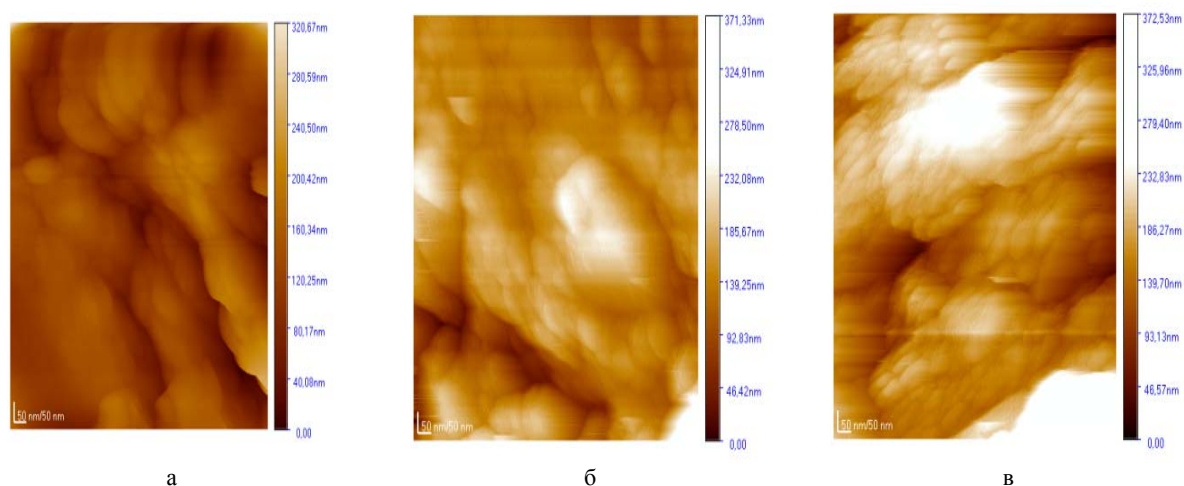
J/J^0	$d, \text{Å}$	$10^4/d^2$ эксп.	hkl	$10^4/d^2$ расч.
1	2	3	4	5
$\text{LaLi}_2\text{CoCuMnO}_6$				
9	4,691	454,4	410	454,4
26	3,891	660,5	500	668,2
5	2,866	1217	631	1230
100	2,742	1330	550	1337
11	2,521	1573	553	1577
18	2,442	1677	651	1657
12	2,320	1858	653	1871
22	2,245	1984	831	1978
7	2,209	2049	832	2058
4	2,024	2441	931	2432
42	1,939	2660	10.0.0	2673
8	1,741	3299	775	3288
8	1,728	3349	10.5.0	3341
32	1,584	3985	10.7.0	3983
16	1,568	4067	12.2.2	4063
9	1,427	4911	12.6.2	4918
11	1,374	5297	14.1.1	5292
11	1,364	5375	14.2.1	5373
12	1,224	6675	10.10.7	6656
$\text{LaNa}_2\text{CoCuMnO}_6$				
24	5,569	322,4	320	322,4
7	4,490	496,0	420	496,0
19	3,862	670,5	511	669,6
100	2,736	1335	552	1339
14	2,315	1866	751	1860
17	2,236	2000	900	2009

1	2	3	4	5
51	1,932	2679	10.2.2	2678
8	1,876	2841	953	2852
5	1,846	2934	10.3.3	2916
5	1,715	3400	11.4.0	3398
36	1,581	4000	12.4.1	3993
14	1,565	4083	10.8.1	4092
3	1,501	4438	13.3.1	4439
15	1,373	5305	14.3.3	5307
11	1,360	5406	13.7.0	5406
12	1,264	6675	16.3.2	6671
12	1,217	6752	16.4.0	6746
LaK ₂ CoCuMnO ₆				
21	3,868	668,4	520	668,4
7	3,097	1042	630	1037
6	2,867	1216	641	1222
100	2,736	1336	730	1337
16	2,527	1566	644	1567
9	2,442	1677	830	1683
14	2,320	1858	900	1867
16	2,240	1993	921	1982
5	2,130	2204	844	2213
36	1,932	2679	10.4.0	2674
6	1,873	2850	11.1.1	2835
8	1,728	3349	980	3342
27	1,580	4006	13.2.1	4010
11	1,569	4062	12.4.4	4057
11	1,373	5305	15.2.1	5301
7	1,358	5422	15.3.1	5416
8	1,229	6620	16.4.4	6638
12	1,222	6697	17.1.1	6707

Удовлетворительное согласие $10^4/d_{\text{экс.}}$ и $10^4/d_{\text{выч.}}$ показывает корректность результатов индирования. На основании индирования рентгенограмм установлено, что все синтезированные наноразмерные (нанокластерные) кобальто-купрато-манганиты кристаллизуются в кубической сингонии со следующими параметрами решетки: LaLi₂CoCuMnO₆ – $a=11,33\pm 0,02 \text{ \AA}$; $V^0=2563,20\pm 0,06 \text{ \AA}^3$; $Z=4$; $V^0_{\text{эл.яч.}}=640,80\pm 0,02 \text{ \AA}^3$; $\rho_{\text{рент.}} = 4,0 \text{ г/см}^3$; LaNa₂CoCuMnO₆ – $a=14,43\pm 0,02 \text{ \AA}$; $V^0=3005,5\pm 0,07 \text{ \AA}^3$; $Z=4$; $V^0_{\text{эл.яч.}}=751,38\pm 0,02 \text{ \AA}^3$; $\rho_{\text{рент.}} = 3,86 \text{ г/см}^3$; LaK₂CoCuMnO₆ – $a=14,90\pm 0,02 \text{ \AA}$; $V^0=3306,90\pm 0,06 \text{ \AA}^3$; $Z=4$; $V^0_{\text{эл.яч.}}=826,52\pm 0,02 \text{ \AA}^3$; $\rho_{\text{рент.}} = 3,68 \text{ г/см}^3$. На основании рентгенофазового анализа также можно предположить, что соединения относятся к пространственной группе *Pm3m*.

По аналогии [20, 21] предположить, что ионы La⁺, Li⁺, Na⁺, K⁺ находятся в центрах элементарных ячеек и имеют координационные числа (к.ч.) по кислороду, равные 12, а в узлах элементарных ячеек находятся ионы Co²⁺, Cu²⁺ и Mn³⁺, к.ч. которых по кислороду равны 6.

В связи с нарастанием ионных радиусов в ряду Li⁺ → Na⁺ → K⁺ также наблюдается увеличение параметра «а», объемов кристаллических решеток и элементарных ячеек.

Выводы. Впервые синтезированы кобальто-купрато-манганиты состава LaMe^I₂CoCuMnO₆ (Me^I – Li, Na, K), получены их наноразмерные (нанокластерные) частицы, методом рентгенографии определены тип их сингонии и параметры решеток.

Работа выполнена согласно договора, заключенного между КН МОН РК и Химико-металлургическим институтом им. Ж.Абишева по гранту ИРН АР05131317.

ЛИТЕРАТУРА

- [1] Третьяков ЮД, Брылев ОА (2000) Журнал РХО им. Д.И. Менделеева [Zhurnal Rossijskogo Himicheskogo Obshchestva im DI Mendeleeva] 65, 4: 10-16.
- [2] Портной КИ, Тимофеев НИ (1986) Кислородные соединения редкоземельных элементов. Металлургия, Москва. ISBN: П260500000-138/040(01)-86
- [3] Суздаев ИП, Суздаев ПИ (2001) Успехи химии [Uspehi himii] 70, 3: 203-240.
- [4] Третьяков ЮД, Гудилин ЕА (2000) Успехи химии [Uspehi himii] 69, 1: 3-39.
- [5] Ерин Ю (2009) Химия и химики [Himija i himiki] 1:16-22 http://chemistry-chemists.com/N1_2009/16-22.pdf
- [6] Келлерман ДГ (2001) Успехи химии [Uspehi himii] 70, 9: 874-889.
- [7] Хороненкова СВ, Еремина ЕА (2002) Вестник МГУ. Серия химическая [Vestnik MGU. Serija himicheskaja] 43, 5: 304-306
- [8] Иванова НБ, Овчинников СГ, Коршунов ММ, Еремин ИМ, Казак НВ (2009) Успехи физических наук [Uspehi fizicheskikh nauk] 179, 8: 837-860.
- [9] Шевельков АВ (2008) Успехи химии [Uspehi himii] 77, 1: 3-22.
- [10] Robert R, Aguirre MH, Hug P, Reller A, Weidenkaff A (2007) High-temperature thermoelectric properties of Ln(Co, Ni)O₃ (Ln=La, Pr, Nd, Sm, Gd and Dy) compounds, Acta Materialia, 55, 15: 4965-4972. <https://doi.org/10.1016/j.actamat.2007.05.020>
- [11] Клындюк АИ, Мацукевич ИВ (2012) Свиридовские чтения [Sviridovskie chtenija] 8:44-50.
- [12] Макина ЕВ, Боровских ЛВ, Кустов АЛ, Мазо ГН, Романовский БВ (2005) Журн. физической химии [Zhurnal fizicheskoi himii] 70, 1: 253-257.
- [13] Балакирев ВФ, Бархатов ВП, Голиков ЮГ, Майзель ОГ (2000) Манганиты: равновесные и нестабильные состояния. УРО РАН, Екатеринбург. ISBN: 5-7691-0968-8
- [14] Мелкозерова МА, Базуев ГВ (2006) Журнал неорганической химии [Zhurnal neorganicheskoi himii] 51, 3: 400-415.
- [15] Медведев ДА, Журавлева ТА, Мурашкина АА, Сергеева ВС, Антонов БД (2010) Журнал физической химии [Zhurnal fizicheskoi himii] 84, 9: 1777-1781.
- [16] Рыкова АИ, Черный АС, Хацько ЕН, Буханько ФН (2009) Наноматериалы [Nanomaterialy] 7, 3: 859-866.
- [17] Касенов БК, Касенова ШБ, Сагинтаева ЖИ, Ермагамбет БТ, Бектурганов НС, Оскембеков ИМ (2017) Двойные и тройные манганиты, ферриты и хромиты щелочных, щелочноземельных и редкоземельных металлов. Научный мир, Москва. ISBN: 978-5-91522-448-2
- [18] Касенов БК, Бектурганов НС., Ермагамбет БТ, Касенова ШБ, Сагинтаева ЖИ, Исабаева МА (2016) Манганиты, хромиты, ферриты щелочных, щелочноземельных и редкоземельных металлов. ТОО «Litera», Караганда. ISBN: 978-601-210-194-2
- [19] Ковба ЛМ, Трунов ВК (1969) Рентгенофазовый анализ. Издательство Московского университета, Москва. ISBN: K20502-147/077(02)-76141-75
- [20] Вест А (1988) Химия твердого тела. Мир, Москва. Ч. 1. ISBN: 5-03-000056-9
- [21] Касенов БК, Оралова АТ, Мустафин ЕС, Жумадилов ЕК (1998) Журнал неорганической химии [Zhurnal neorganicheskoi himii] 43, 2: 196-197

**Ш.Б. Қасенова¹, Б.Қ. Қасенов¹, Ж.И. Сағынтаева¹,
М.О. Түртүбаева², Е.Е. Қуанышбеков¹**

¹ – Ж.Әбішев атындағы Химия-металлургия институты, Қарағанды, Қазақстан;

² – С.Торайғыров атындағы Павлодар мемлекеттік университеті, Павлодар, Қазақстан

**ЛАНТАН ЖӘНЕ СІЛТІЛІ МЕТАЛДАРДЫҢ ЖАҢА НАНОӨЛШЕМДІ
(НАНОКЛАСТЕРЛІК) КОБАЛЬТ-КУПРАТ-МАНГАНИТТЕРІ
ЖӘНЕ ОЛАРДЫ РЕНТГЕНОГРАФИЯЛЫҚ ТҮРҒЫДАН ЗЕРТТЕУ**

Аннотация. Жаңа қосарласқан марганец, мыс және кобальтқұрамды наноматериалдарға ізденіс және олардың қасиеттеріне зерттеулер жүргізу бейорганикалық материалдануда, әсіресе микроэлектроника үшін елеулі қызығушылық тудырады.

Осындай қосылыстарға қызығушылық олардың берілген қасиеттерінің полифункционалдылығымен және құрамдарының периодтық жүйенің көптеген элементерін қабылдау икемділігімен байланысты.

Керамикалық технологиямен лантан (III), кобальт(II), мыс (II), марганец (III) тотықтары мен литий, натрий және калий карбонаттарынан 800-1200 °C аралықта $\text{LaMe}^I_2\text{CoCuMnO}_6$ ($\text{Me}^I - \text{Li, Na, K}$) құрамды кобальт-купрат-манганиттері синтезделініп алынды.

Әрбір 100 °C сайын құрамдар суытылып, араластырылып және қайта қыздырылды. Төмен температурада тепе-тең фазалар алу үшін 10 сағат бойы 400 °C-та төмен температуралық қыздыру жүргізілді.

Retsch (Германия) компаниясының «ММ301» маркалы вибрациялық диірменінде үгіту жолымен олардың наноөлшемді (нанокластерлік) бөлшектері алынды, «JSPM-5400» Scanning Probe Microscope «JEOL» (Япония) электрондық микроскопында олардың өлшемдері анықталды.

Қосылыстардың өлшемі 40-90 нм болатын нанобөлшекті (нанокластері) алынды.

Жаңа қосылыстарға рентгенофазалық талдау ДРОН-2,0 дифрактометрінде жасалды. Рентгенограммаларын аналитикалық әдіспен индицирлеу барысында синтезделініп алынған наноөлшемді жаңа фазалардың тор көрсеткіштері келесідей кубтық сингонияда кристалданатыны анықталды: $\text{LaLi}_2\text{CoCuMnO}_6 - a=11,33\pm 0,02 \text{ \AA}; V^0=2563,20\pm 0,06 \text{ \AA}^3; Z=4; V^0_{\text{эл.үя.}}=640,80\pm 0,02 \text{ \AA}^3; \rho_{\text{рент.}} = 4,0 \text{ г/см}^3$; $\text{LaNa}_2\text{CoCuMnO}_6 - a=14,43\pm 0,02 \text{ \AA}; V^0=3005,5\pm 0,07 \text{ \AA}^3; Z=4; V^0_{\text{эл.үя.}}=751,38\pm 0,02 \text{ \AA}^3; \rho_{\text{рент.}} = 3,86 \text{ г/см}^3$; $\text{LaK}_2\text{CoCuMnO}_6 - a=14,90\pm 0,02 \text{ \AA}; V^0=3306,90\pm 0,06 \text{ \AA}^3; Z=4; V^0_{\text{эл.үя.}}=826,52\pm 0,02 \text{ \AA}^3; \rho_{\text{рент.}} = 3,68 \text{ г/см}^3$. Рентгенофазалық талдау негізінде алынған наноөлшемді кобальт-купрат-манганиттердің $Pm\bar{3}m$ кеңістіктік топқа жататынын болжауға болады.

Түйін сөздер: кобальт, купрат, манганит, лантан, сілтілі металл, синтез, нанобөлшектер, рентгенография.

Сведения об авторах:

Касенов Булат Кунурович – д.х.н., профессор, заведующий лабораторией термохимических процессов Химико-металлургического института им. Ж.Абишева, E-mail: kasenov1946@mail.ru, телефон (рабочий) 7212433516.

Касенова Шуга Булатовна – д.х.н., профессор, главный научный сотрудник лаборатории термохимических процессов Химико-металлургического института им. Ж.Абишева, E-mail: kasenovashuga@mail.ru, телефон (рабочий) 7212433516.

Сагинтаева Женисгуль Имангалиевна – к.х.н., ассоц. профессор, ведущий научный сотрудник лаборатории термохимических процессов, Химико-металлургического института им. Ж.Абишева, Химико-металлургического института им. Ж.Абишева, E-mail: kai_sagintaeva@mail.ru, телефон (рабочий) 7212433516.

Куанышбеков Ерболат Ермакович – магистр технических наук, ведущий инженер лаборатории термохимических процессов Химико-металлургического института им. Ж.Абишева, E-mail: mr.ero1986@mail.ru, телефон (рабочий) 7212433516.

Туртубаева Меруерт Оразгалиевна – PhD химических наук, преподаватель Павлодарского государственного университета им. С. Торайгырова, E-mail: azat-2000@bk.ru.

NEWS

OF THE NATIONAL ACADEMY OF SCIENCES OF THE REPUBLIC OF KAZAKHSTAN

SERIES CHEMISTRY AND TECHNOLOGY

ISSN 2224-5286

Volume 3, Number 429 (2018), 73 – 78

**Zh.I. Sagintaeva¹, B.K. Kasenov¹, Sh.B. Kasenova¹,
M.O. Turtubaeva², E.E. Kuanyshbekov¹**

¹ – Zh. Abishev Chemical-Metallurgical Institute, Karaganda, Kazakhstan kasenov1946@mail.ru

² – S.Toraighyrov Pavlodar State University, Pavlodar, Kazakhstan

SYNTHESIS AND X-RAY OF NEW NANOSIZED (NANOCLUSTER) NICKELITE-CUPRATE-MANGANITES OF LANTHANUM AND ALKALINE METALS

Abstract. The main tendency in the development of microelectronics is miniaturization and increase in the speed of various devices. For storage devices, such as dynamic and static RAM, based on capacitive components (capacitors), this means that as the size of the capacitor decreases, its capacitance must remain the same [1].

The cuprates of REE are actively studied primarily as objects of high-temperature superconductivity (HTSC) compounds, cathode materials and catalysts. Lanthanum nickelites are promising materials as fuel cell cathodes.

The problems of synthesis and X-ray analysis of new nano-sized nickelite-cuprate-manganites of the composition $\text{LaMe}_2\text{NiCuMnO}_6$ where ($\text{Me}^1\text{-Li, Na, K}$) are considered for the first time in this paper.

The nickelite-cuprate-manganites of the composition $\text{LaMe}_2\text{NiCuMnO}_6$ ($\text{Me} - \text{Li, Na, K}$) are synthesized by solid-phase interaction in the range 800-1200 ° C from the oxides of lanthanum (III), nickel (II), copper (II), manganese (III) and lithium, sodium and potassium carbonates. Their nanoscale (nanoclusters) particles were obtained by grinding them on a vibratory mill "MM301" from Retsch (Germany). On the electron microscope "JSPM-5400" Scanning Probe Microscope "JEOL" (Japan) their sizes are determined. By X-ray diffraction analysis of compounds on the DRON-2.0 diffractometer and the indication of their X-ray diffraction patterns, analytical methods were used to determine the types of syngony and the parameters of the grids of the synthesized new phases: $\text{LaLi}_2\text{NiCuMnO}_6$ (cub.) – $a=13,83\pm 0,02 \text{ \AA}$, $V^0=2644,16\pm 0,06 \text{ \AA}^3$, $Z=4$, $V^0_{el.cell}=661,04\pm 0,02 \text{ \AA}^3$, $\rho_{X\text{-ray}}=4,03 \text{ g/cm}^3$; $\text{LaNa}_2\text{NiCuMnO}_6$ (cub.) – $a=14,19\pm 0,02 \text{ \AA}$, $V^0=2859,42\pm 0,06 \text{ \AA}^3$, $Z=4$, $V^0_{el.cell}=714,86\pm 0,01 \text{ \AA}^3$, $\rho_{X\text{-ray}}=3,38 \text{ g/cm}^3$; $\text{LaK}_2\text{NiCuMnO}_6$ (cub) – $a=15,17\pm 0,02 \text{ \AA}$, $V^0=3492,0\pm 0,06 \text{ \AA}^3$, $Z=4$, $V^0_{el.cell}=873,0\pm 0,01 \text{ \AA}^3$, $\rho_{X\text{-ray}}=3,70 \text{ g/cm}^3$.

Key words: nickelite, cuprate, manganite, lanthanum, alkaline metals.

УДК 546.05+548.3+54-31+546.742:562:713: 654:31

**Ж.И. Сагинтаева¹, Б.К. Касенов¹, Ш.Б. Касенова¹,
М.О. Туртубаева², Е.Е. Куанышбеков¹**

¹ Химико-металлургический институт им. Ж. Абишева, Караганда, Казахстан;

² Павлодарский гос. университет им. С. Торайгырова, Павлодар, Казахстан

СИНТЕЗ И РЕНТГЕНОГРАФИЯ НОВЫХ НАНОРАЗМЕРНЫХ (НАНОКЛАСТЕРНЫХ) НИКЕЛИТО-КУПРАТО-МАНГАНИТОВ ЛАНТАНА И ЩЕЛОЧНЫХ МЕТАЛЛОВ

Аннотация: Основной тенденцией в развитии микроэлектроники является миниатюризация и увеличение быстродействия различных устройств. Для запоминающих устройств, вроде динамической и статической оперативной памяти, основанных на емкостных компонентах (конденсаторах), это означает, что при уменьшении размеров конденсатора величина его емкости должна оставаться прежней [1].

Купраты РЗЭ активно исследуются прежде всего как объекты высокотемпературной сверхпроводимости (ВТСП) соединений, катодные материалы и катализаторы.

Никелиты лантана являются перспективными материалами в качестве катодов топливных ячеек.

В данной работе впервые рассматриваются вопросы синтеза и рентгенографического анализа новых наноразмерных никелито-купрато-манганитов состава $\text{LaMe}_2^1\text{NiCuMnO}_6$ где $\text{Me}^1 - \text{Li, Na, K}$.

Твердофазным взаимодействием в интервале 800-1200°C из оксидов лантана (III), никеля (II), меди (II), марганца (III) и карбонатов лития, натрия и калия синтезированы никелито-купрато-манганиты состава $\text{LaMe}_2^1\text{NiCuMnO}_6$ ($\text{Me} - \text{Li, Na, K}$). Путем измельчения на вибрационной мельнице марки «ММ301» компании Retsch (Германия) получены их наноразмерные (нанокластерные) частицы. На электронном микроскопе «JSPM-5400» Scanning Probe Microscope «JEOL» (Япония) определены их размеры. Проведением рентгенофазового анализа соединений на дифрактометре ДРОН-2,0 и индицированием их рентгенограмм аналитическим методом определены типы сингонии и параметры решеток синтезированных новых фаз: $\text{LaLi}_2\text{NiCuMnO}_6$ (куб.) – $a=13,83\pm 0,02 \text{ \AA}$, $V^0=2644,16\pm 0,06 \text{ \AA}^3$, $Z=4$, $V^0_{\text{эл.яч.}}=661,04\pm 0,02 \text{ \AA}^3$, $\rho_{\text{рент.}}=4,03 \text{ г/см}^3$; $\text{LaNa}_2\text{NiCuMnO}_6$ (куб.) – $a=14,19\pm 0,02 \text{ \AA}$, $V^0=2859,42\pm 0,06 \text{ \AA}^3$, $Z=4$, $V^0_{\text{эл.яч.}}=714,86\pm 0,01 \text{ \AA}^3$, $\rho_{\text{рент.}}=3,38 \text{ г/см}^3$; $\text{LaK}_2\text{NiCuMnO}_6$ (куб.) – $a=15,17\pm 0,02 \text{ \AA}$, $V^0=3492,0\pm 0,06 \text{ \AA}^3$, $Z=4$, $V^0_{\text{эл.яч.}}=873,0\pm 0,01 \text{ \AA}^3$, $\rho_{\text{рент.}}=3,70 \text{ г/см}^3$.

Ключевые слова: никелит, купрат, манганит, лантан, щелочные металлы.

Сложные оксиды переходных 3d- и 4f-элементов со структурой перовскита или близкие к ней, как манганиты, никелиты, никелаты и купраты редкоземельных элементов, легированные оксидами щелочных и щелочноземельных металлов, благодаря наличию прекрасных физико-химических свойств, как большие величины электропроводности, диэлектрической проницаемости, полупроводниковый характер проводимости, магнитные и сверхпроводящие свойства [1-16].

В лаборатории термохимических процессов Химико-металлургического института им. Ж. Абишева проводятся систематические исследования по синтезу и изучению кристаллохимических, термодинамических и электрофизических свойств манганитов, хромитов и ферритов, допированных оксидами щелочных и щелочноземельных металлов. По результатам исследований опубликованы многочисленные статьи в рецензируемых журналах с ненулевым импакт-факторами, получены ряд охранных документов и основные результаты обобщены в следующих работах [17, 18].

Для неорганического материаловедения, химии и технологии полифункциональных соединений имеет, на наш взгляд, определенное значение получение никелитов, купратов и манганитов в одном комплексе, как никелито-купрато-манганитов.

Для решения этого вопроса в данной работе приведены результаты синтеза и рентгенографического анализа новых наноразмерных никелито-купрато-манганитов состава $\text{LaMe}_2^1\text{NiCuMnO}_6$ где $\text{Me}^1 - \text{Li, Na, K}$.

Для синтеза указанных соединений использовались оксид лантана (III), марки «ос.ч.», оксиды никеля (III), меди (II), марганца (III), карбонаты лития, натрия, калия квалификации «ч.д.а.», стехиометрические количества их в перерасчете на формульные единицы получаемых никелито-купрато-манганитов тщательно перемешивались и перетирались. Для получения устойчивых при низкой температуре модификаций проводили отжиг смесей при 400°C в течение 10 часов.

Наноразмерные (нанокластерные) частицы синтезированных никелито-купрато-манганитов получали измельчением поликристаллических образцов на вибрационной мельнице «ММ301» компании Retsch (Германия). Размеры нанокластеров определены с использованием электронного микроскопа «JSPM-5400» Scanning Probe Microscope «JEOL» (Япония). Получены наночастицы, нанокластеры размерами от 50 до 150 нм. Ниже на рисунке приведены электронно-микроскопические снимки соединений.



Рисунок - Электронная микроскопия $\text{LaLi}_2\text{NiCuMnO}_6$ (а), $\text{LaNa}_2\text{NiCuMnO}_6$ (б), $\text{LaK}_2\text{NiCuMnO}_6$ (в)

Рентгенографическое исследование наноразмерных образцов проводили на установке ДРОН-2,0. Интенсивность дифракционных максимумов оценивали по 100 балльной шкале. Индексирование рентгенограмм новых наноразмерных соединений проводили аналитическим методом [19].

В таблице приведены результаты индексирования полученных новых фаз.

Таблица – Индексирование рентгенограмм никелито-купрато-манганитов

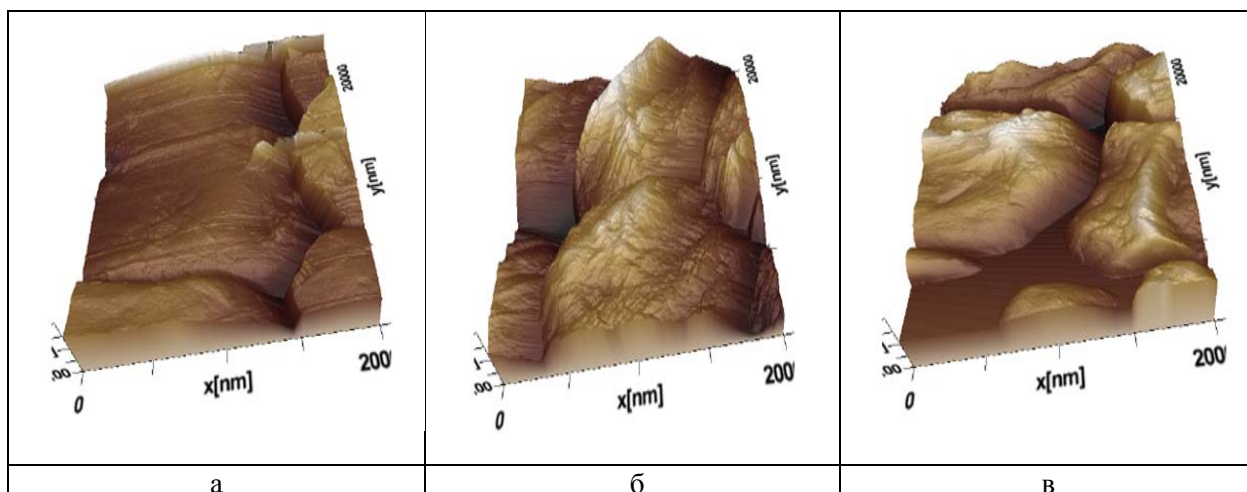
1/ θ °	d, Å	$10^4/d^2_{\text{эксп.}}$	hkl	$10^4/d^2_{\text{расч.}}$
1	2	3	4	5
$\text{LaLi}_2\text{NiCuMnO}_6$				
20	4,777	438,2	400	438,0
28	3,862	670,5	500	684,7
100	2,721	1351	700	1342
14	2,522	1572	722	1561
11	2,431	1692	651	1628
11	2,321	1856	820	1862
21	2,235	2002	830	1999
20	2,211	2046	751	2054
19	2,071	2332	920	2328
33	1,932	2679	853	2684
20	1,911	2738	10.0.0	2739
10	1,720	3380	11.1.1	3369
27	1,580	4006	11.5.0	3999
25	1,565	4083	10.7.0	4081
11	1,465	4659	13.1.0	4656
7	1,422	4945	10.9.0	4957
9	1,371	5320	13.5.0	5313
10	1,220	6719	15.4.2	6710
8	1,210	6830	10.10.7	6819
$\text{LaNa}_2\text{NiCuMnO}_6$				
21	3,862	670,5	510	670,0
5	3,599	772,0	521	773,7
6	3,458	836,3	440	825,2
5	3,061	1067	621	1057
100	2,735	1337	640	1341
10	2,520	1575	650	1573
14	2,4310	1692	811	1702
11	2,324	1851	660	1857
7	2,201	2064	840	2063

1	2	3	4	5
10	2,102	2263	664	2269
47	1,9300	2685	862	2682
4	1,8550	2906	870	2914
8	1,736	3318	881	3327
9	1,718	3388	11.3.1	3378
36	1,582	3996	975	3997
LaK ₂ NiCuMnO ₆				
14	3,865	669,4	520	669,0
100	2,742	1330	730	1339
15	2,526	1567	644	1570
12	2,420	1708	750	1708
13	2,329	1844	840	1847
18	2,240	1993	655	1985
15	2,094	2281	755	2285
35	1,935	2671	10.4.0	2678
4	1,858	2897	10.5.1	2908
5	1,730	3341	12.1.0	3347
28	1,582	3996	12.5.2	3993
9	1,479	4572	13.5.2	4570
4	1,263	6269	16.4.0	6279
10	1,224	6675	17.0.0	6671
4	1.210	6830	16.6.2	6832

Удовлетворительно согласие опытных и расчетных значений $10^4/d^2$ подтверждает корректность результатов индцирования (таблица). На основании индцирования рентгенограмм новых наноразмерных (нанокластерных) фаз установлено, что они кристаллизуются в кубической сингонии со следующими параметрами решетки: LaLi₂NiCuMnO₆ – $a=13,83\pm 0,02$ Å, $V^o=2644,16\pm 0,06$ Å³, $Z=4$, $V^o_{эл.яч.}=661,04\pm 0,02$ Å³, $\rho_{рент.}=4,03$ г/см³; LaNa₂NiCuMnO₆ – $a=14,19\pm 0,02$ Å, $V^o=2859,42\pm 0,06$ Å³, $Z=4$, $V^o_{эл.яч.}=714,86\pm 0,01$ Å³, $\rho_{рент.}=3,38$ г/см³; LaK₂NiCuMnO₆ – $a=15,17\pm 0,02$ Å, $V^o=3492,0\pm 0,06$ Å³, $Z=4$, $V^o_{эл.яч.}=873,0\pm 0,01$ Å³, $\rho_{рент.}=3,70$ г/см³. Согласно [20, 21] можно предполагать, что ионы La³⁺ и Me⁺ (Li⁺, Na⁺, K⁺) находятся в центрах элементарных ячеек и имеют координационные числа (к.ч.) по кислороду, равные 12, а в узлах элементарных ячеек находятся ионы Ni²⁺, Cu²⁺ и Mn³⁺, к.ч. которых по кислороду равные 6.

Наблюдается закономерность, которая заключается в том, что с увеличением ионных радиусов в ряду Li→Na→K также возрастают значения параметров решетки (a , V^o , $V^o_{эл.яч.}$).

Резюмируя вышеизложенное можно сказать, что впервые методом керамической технологии синтезированы никелито-купрато-манганиты LaMe₂¹NiCuMnO₆ (Me¹ – Li, Na, K), получены, их наноразмерные (нанокластерные) частицы, определены также их параметры решеток.

Работа выполнена согласно договора, заключенного между КН МОН РК и Химико-металлургическим институтам им. Ж. Абишева по гранту (ИРН: AP05131333).

ЛИТЕРАТУРА

- [1] Ерин Ю (2009) Химия и Химики [Himija i himiki] 1: 16-22. <http://chemistryandchemists.narod.ru>.
- [2] Матвеев ЕА (2008) Физические свойства твердых растворов La_{2-x}Ca_xNiO_{4+δ}: автореф. дисс....канд. физ.- мат. наук [avtoref. diss....kand. fiz.- mat. nauk. avtoref. diss....kand. fiz.- mat. nauk] [avtoref. diss....kand. fiz.- mat. nauk. avtoref. diss....kand. fiz.- mat. nauk] Москва. 119.
- [3] Мелкозерова МА, Заболоцкая ЕВ, Келлерман ДГ, Семенова АС, Медведев ЕЮ, Базуев ГВ. (2011) Физика твердого тела [Fizika tverdogo tela] 53, 2: 302-307.
- [4] Третьяков ЮД, Брылёв ОА (2000) Журнал РХО им. Д.И. Менделеева [Zhurnal Rossijskoe Himicheskoe Obshestvo im. D.I. Mendeleeva] 45, 4: 10-16.
- [5] Norpoth J, Su D, Inada H, Sievers S, Zhu Y, Jooss Ch (2012) Interfacial reconstruction and superconductivity in cuprate-manganite multilayers of YBa₂Cu₃O₇ and Pr_{0,68}Ca_{0,32}MnO₃, New Journal of Physics 14/ 093009: 1-15. <https://doi.org/10.1088/1367-2630/14/9/093009>.
- [6] John Y, Wei T. (2002) Spin-Injection Quasiparticle Nonequilibrium in Cuprate/Manganite Heterostructures, *Journal of Superconductivity*, 15, 1: 67–70 <https://doi.org/10.1023/A:1014079211158>.

[7] Федорченко В.П., Лашкарев Г.В., Зырин А.В., Матвеев Е.А., Малкин Е.И. (2006) Электрические и магнитные свойства никелита лантана легированного кальцием $\text{La}_{2-x}\text{Ca}_x\text{NiO}_4$ при $x = 0; 0.1; 0.2; 0.3; 0.4$ [Jelektricheskie i magnitnye svojstva nikelita lantana legirovanogo kal'ciem $\text{La}_{2-x}\text{Ca}_x\text{NiO}_4$ pri $x = 0; 0.1; 0.2; 0.3; 0.4$] III Международная конференция по физике кристаллов «Кристаллофизика XXI века», Москва. С.120.

[8] Miao-Miao Deng, Bang-Kun Zou, Yu Shao, Zhong-Feng Tang, Chun-Hua Chen (2017) Comparative study of the electrochemical properties of $\text{LiNi}_{0.5}\text{Mn}_{1.5}\text{O}_4$ doped by bivalent ions (Cu^{2+} , Mg^{2+} , and Zn^{2+}), Journal of Solid State Electrochemistry, 21, 6: 1733-1742. <https://doi.org/10.1007/s10008-017-3545-z>.

[9] Sen Chen, Enshan Han, Han Xu, Lingzhi Zhu, Bin Liu, Guangquan Zhang. Min Lu (2017) P_2 -type $\text{Na}_{0.67}\text{Ni}_{0.33-x}\text{Cu}_x\text{Mn}_{0.67}\text{O}_2$ as new high-voltage cathode materials for sodium-ion batteries, International Journal Ionics, 23, 11: 3057-3066. <https://doi.org/10.1007/s11581-017-2122-x>.

[10] Yang-huan Zhang, Ya-qin Li, Hong-wei Shang, Ze-Ming Yuan, Tai Yang, Shi-hai Guo. (2017) Structures and hydrogen storage performances of rare earth-Mg-Ni-Mn-based AB_2 -type alloys applied to Ni-MH battery, Journal of Solid State Electrochemistry, 21, 4: 1015–1025. <https://doi.org/10.1007/s10008-016-3455-5>.

[11] Archana Singh, Ajendra Singh, Satyendra Singh, Poonam Tandon, R. R. Yadav. (2016) Synthesis, Characterization and Gas Sensing Capability of $\text{Ni}_x\text{Cu}_{1-x}\text{Fe}_2\text{O}_4$ ($0.0 \leq x \leq 0.8$) Nanostructures Prepared via Sol-Gel Method, Journal of Inorganic and Organometallic Polymers and Materials, 26, 6: 1392–1403. <https://doi.org/10.1007/s10904-016-0428-1>.

[12] Zi-Zhen Lin, Cong-Liang Huang, Wen-Kai Zhen, Yan-Hui Feng, Xin-Xin Zhang and Ge Wang. (2017) Experimental Study on Thermal Conductivity and Hardness of Cu and Ni Nanoparticle Packed Bed for Thermoelectric Application, Nanoscale Research Letters, 12:189. <https://doi.org/10.1186/s11671-017-1969-0>.

[13] Пашенко АВ, Пашенко ВП, Прокопенко ВК, Сильчева АГ, Ревенко ЮФ, Шемяков АА, Кисель НГ, Комаров ВП, Сычева ВЯ, Горбань СВ, Погребняк ВГ. (2012) Физика твердого тела [Fizika tverdogo tela] 54, 4: 720-729.

[14] Демина АН (2006) Фазовая индивидуальность, структура, термические и электрические свойства легированных манганитов лантана $\text{La}_{1-x}\text{Sr}_x\text{Mn}_{1-y}\text{M}_y\text{O}_{3\pm d}$ ($M = \text{Ti, Fe, Ni}$): автореф. дисс....канд. хим. наук [avtoref. diss....kand. him. Nauk] Екатеринбург. 26.

[15] Гараева МЯ, Черных ИА, Крылова ТС, Шайнуров РИ, Красноперов ЕП, Занавескин МЛ (2014) Письма в ЖТФ [Pis'ma v ZhTF] 40, 20: 47-53.

[16] Ali Tarjomannejad, Aligholi Niaei, María José Illán Gómez, Ali Farzi, D ariush Salari, Vicente Albaladejo-Fuentes. (2017) NO+CO reaction over $\text{LaCu}_{0.7}\text{B}_{0.3}\text{O}_3$ ($B = \text{Mn, Fe, Co}$) and $\text{La}_{0.8}\text{A}_{0.2}\text{Cu}_{0.7}\text{Mn}_{0.3}\text{O}_3$ ($A = \text{Rb, Sr, Cs, Ba}$) perovskite-type catalysts, Journal of Thermal Analysis and Calorimetry, 129, 2: 671–680. <https://doi.org/10.1007/s10973-017-6264-x>.

[17] Касенов БК, Касенова ШБ, Сагинтаева ЖИ, Ермагамбет БТ, Бектурганов НС, Оскембеков ИМ (2017) Двойные и тройные манганиты, ферриты и хромиты щелочных, щелочноземельных и редкоземельных металлов. «Научный мир», Москва. ISBN 978-5-91522-448-2.

[18] Bekturganova AZh, Kasenova ShB, Sagintayeva ZhI, Kasenov BK, Rustembekov KT, Stoyev M. (2017) Calorimetric study of the heat capacity of nickelitic manganites $\text{LaM}_2\text{NiMnO}_5$ ($M = \text{Li, Na, K}$) in the temperature range 298.15-673 K, High Temperature, 55, 3: 465-468. <https://doi.org/10.1134/S0018151X17030026>

[19] Ковба ЛМ, Трунов ВК (1969) Рентгенофазовый анализ. Изд-во МГУ, М. К 20502-147/077(02)-76 141-75.

[20] Вест А (1988) Химия твердого тела. Мир, М. ISBN 50-03-000056-9.

[21] Касенов БК, Оралова АТ, Мустафин ЕС, Жумадилов ЕК (1998) Журнал неорган. химии [Zhurnal neorgan. Himii] 43, 2: 196-197.

**Ж.И. Сағынтаева¹, Б.Қ. Қасенов¹, Ш.Б. Қасенова¹,
М.О. Түртүбаева², Е.Е. Қуанышбеков¹**

1 - Ж. Әбішев атындағы Химия-металлургия институты, Қарағанды қ.
2 – С. Торайғыров атындағы Павлодар мемлекеттік университеті, Павлодар қ.

ЖАҢА НАНОӨЛШЕМДІ (НАНОКЛАСТЕРЛІК) НИКЕЛИТ-КУПРАТ-МАНГАНИТТЕРДІҢ СИНТЕЗІ ЖӘНЕ РЕНТГЕНОГРАФИЯСЫ

Аннотация. Микроэлектрониканың дамуындағы негізгі тенденция болып түрлі құрылғылардың тезәсеретуін ұлғайту мен оларды миниатюризациялау болып табылады.

Динамикалық және статикалық оперативтік жадылар сияқты сыйымдылық компоненттерге (конденсаторларға) негізделген жадыда сақтау құрылғыларда бұл деген конденсатордың өлшемі кішірейтілген кезде оның сыйымдылық шамасы бұрынғыдай қалу керек [1].

СЖЭ купраттары бәрінен бұрын жоғарытемпературалы аскынөткізгішті (ЖТАӨ) үлгілер, катодты материалдар және катализаторлар ретінде белсенді зерттелуде.

Лантан никелиттері жану ұяшықтарында катод ретінде келелі материалдар болып табылады.

Берілген жұмыста алғаш рет $\text{LaMe}_2^{\text{I}}\text{NiCuMnO}_6$ мұндағы $\text{Me}^{\text{I}} - \text{Li, Na, K}$ құрамды жаңа наноөлшемді никелит-купрат-манганиттердің синтезі және рентгенографиялық талдау сұрақтары қарастырылған.

Лантан (III), никель (II), мыс (II), марганец (III) тотықтары және литий, натрий және калий карбонаттарының қатты фазалы әрекеттесуі арқылы 800-1200°C аралықта $\text{LaMe}_2^{\text{I}}\text{NiCuMnO}_6$ ($\text{Me} - \text{Li, Na, K}$) құрамды никелит-купрат-манганиттері синтезделініп алынды.

Retsch (Германия) компаниясының «ММ301» маркалы вибрациялық диірменінде үгіту жолымен олардың наноөлшемді (нанокластерлік) бөлшектері алынды.

«JSPM-5400» Scanning Probe Microscope «JEOL» (Япония) электрондық микроскопында олардың өлшемдері анықталды.

ДРОН-2,0 дифрактометрінде қосылыстарға рентгенофазалық талдау жүргізілді және олардың рентгенограммаларын аналитикалық әдіспен индицирлеу барысында синтезделініп алынған жаңа фазалардың сингония типі мен тор көрсеткіштері анықталды: $\text{LaLi}_2\text{NiCuMnO}_6$ (куб.) – $a=13,83\pm 0,02 \text{ \AA}$, $V^{\circ}=2644,16\pm 0,06 \text{ \AA}^3$, $Z=4$, $V^{\circ}_{\text{эл.ұя.}}=661,04\pm 0,02 \text{ \AA}^3$, $\rho_{\text{рент.}}=4,03 \text{ г/см}^3$; $\text{LaNa}_2\text{NiCuMnO}_6$ (куб.) – $a=14,19\pm 0,02 \text{ \AA}$, $V^{\circ}=2859,42\pm 0,06 \text{ \AA}^3$, $Z=4$, $V^{\circ}_{\text{эл.ұя.}}=714,86\pm 0,01 \text{ \AA}^3$, $\rho_{\text{рент.}}=3,38 \text{ г/см}^3$; $\text{LaK}_2\text{NiCuMnO}_6$ (куб.) – $a=15,17\pm 0,02 \text{ \AA}$, $V^{\circ}=3492,0\pm 0,06 \text{ \AA}^3$, $Z=4$, $V^{\circ}_{\text{эл.ұя.}}=873,0\pm 0,01 \text{ \AA}^3$, $\rho_{\text{рент.}}=3,70 \text{ г/см}^3$.

Тірек сөздер: никелит, купрат, манганит, лантан, сілітілі металдар.

Сведения об авторах:

Касенов Булат Кунурович – д.х.н., профессор, заведующий лабораторией термохимических процессов Химико-металлургического института им. Ж.Абишева, E-mail: kasenov1946@mail.ru, телефон (рабочий) 7212433516.

Касенова Шуга Булатовна – д.х.н., профессор, главный научный сотрудник лаборатории термохимических процессов Химико-металлургического института им. Ж.Абишева, E-mail: kasenovashuga@mail.ru, телефон (рабочий) 7212433516.

Сагинтаева Женисгуль Имангалиевна – к.х.н., ассоц. профессор, ведущий научный сотрудник лаборатории термохимических процессов, Химико-металлургического института им. Ж.Абишева, E-mail: kai_sagintaeva@mail.ru, телефон (рабочий) 7212433516.

Куанышбеков Ерболат Ермакович – магистр технических наук, ведущий инженер лаборатории термохимических процессов Химико-металлургического института им. Ж.Абишева, E-mail: mr.ero1986@mail.ru, телефон (рабочий) 7212433516.

Туртубаева Меруерт Оразгалиевна – PhD химических наук, преподаватель Павлодарского государственного университета им. С. Торайгырова, E-mail: azat-2000@bk.ru.

NEWS

OF THE NATIONAL ACADEMY OF SCIENCES OF THE REPUBLIC OF KAZAKHSTAN

SERIES CHEMISTRY AND TECHNOLOGY

ISSN 2224-5286

Volume 3, Number 429 (2018), 79 – 85

УДК 542.8:544.14:539.19

A.M. Tatenov, V.V. Savelyeva, A.S. Kaliev

Euroasian technological university, Almaty, Kazakhstan.

tatenov_adambek@mail.ru, vika-sova@mail.ru**THE MECHANISM OF COMPOUND OF CHEMICAL ELEMENTS
FOR THE TABLE OF D.I. MENDELEYEV AND THE VIRTUAL
INTERAKTIVIZATION IN THE PROGRAM ENVIRONMENT
FLASH-CC, JAVA SCRIPT**

Abstract. It is asked creations of the virtual interactive laboratories with obviousness of deep mechanisms of chemical reactions at the atomic level in inorganic chemistry.

On the basis of a research practical use of results of the virtual laboratory operated (interactive) with visualization and animation of mechanisms course of processes, on inorganic and organic chemistry are planned. Will be applied to upgrading of tutoring, big saving of time (about 60% for assimilation of a subject), to self-contained carrying out research works, to development of creativity of students. The product will be used all system of secondary education (schools, lyceums, gymnasiums), all system of the higher education where study chemistry, research institutes and laboratories and also food, chemical, pharmaceutical, other technological industries.

Keywords: periodic system of elements, atom, electron, proton, neutron, atomic weight, Pauli's exclusion principle, rule Hunda, orbital, energy levels, valence.

УДК 542.8:544.14:539.19

А.М. Татенов, В.В. Савельева, А.С. Калиев

Евразийский технологический университет. Г. Алматы. Казахстан.

**МЕХАНИЗМ СОЕДИНЕНИЯ ХИМИЧЕСКИХ ЭЛЕМЕНТОВ ТАБЛИЦЫ
Д.И.МЕНДЕЛЕЕВА И ВИРТУАЛЬНАЯ ИНТЕРАКТИВИЗАЦИЯ
В ПРОГРАММНОЙ СРЕДЕ FLASH-CC, JAVA SCRIPT**

Аннотация. Ставится вопрос создания виртуальных интерактивных лаборатории с наглядностью глубинных механизмов химических реакций на атомарном уровне по неорганической химии.

На основе исследования планируются практические применения результатов виртуально-управляемой (интерактивная) лаборатории с визуализацией и анимацией механизмов протекания процессов, по неорганической и органической химии. Будут применяться для повышения качества обучения, большой экономии времени (около 60% на усвоение предмета), для самостоятельного проведения исследовательских работ, для развития творчества обучающихся. Продукт будут использовать вся система среднего образования (школы, лицеи, гимназии), вся система высшего образования где изучают химию, научно-исследовательские институты и лаборатории, а также пищевая, химическая, фармацевтическая, другие технологические индустрии.

Ключевые слова: периодическая система элементов, атом, электрон, протон, нейтрон, атомная масса, принцип Паули, правило Хунда, орбиталь, энергетические уровни, валентность,

Введение.

Периодический закон – величайшее достижение химической науки, основа всей современной химии. С его открытием химия перестала быть описательной наукой, в ней стало возможным научное предвидение.

Периодический закон открыт Д. И. Менделеевым в 1869 г. Ученый сформулировал этот закон так: «Свойства простых тел, также формы и свойства соединений элементов находятся в периодической зависимости от величины атомных весов элементов» [1, 2].

Более детальное изучение строения вещества показало, что периодичность свойств элементов обусловлена не атомной массой, а электронным строением атомов.

Заряд ядра является характеристикой, определяющей электронное строение атомов, а следовательно, и свойства элементов. Поэтому в современной формулировке Периодический закон звучит так: свойства простых веществ, а также формы и свойства соединений элементов находятся в периодической зависимости от порядкового номера (от величины заряда ядра их атомов). Выражением Периодического закона является периодическая система элементов.

Периодическая система Д. И. Менделеева

Периодическая система элементов Д. И. Менделеева состоит из семи периодов, которые представляют собой горизонтальные последовательности элементов, расположенные по возрастанию заряда их атомного ядра. Периоды 1, 2, 3, 4, 5, 6 содержат соответственно 2, 8, 8, 18, 18, 32 элемента. Седьмой период не завершен. Периоды 1, 2 и 3 называют *малыми*, остальные – *большими*.

Каждый период (за исключением первого) начинается атомами щелочных металлов (Li, Na, K, Rb, Cs, Fr) и заканчивается благородным газом (Ne, Ar, Kr, Xe, Rn), которому предшествует типичный неметалл. В периодах слева направо постепенно ослабевают металлические и усиливаются неметаллические свойства, поскольку с ростом положительного заряда ядер атомов возрастает число электронов на внешнем уровне [2].

В первом периоде, кроме гелия, имеется только один элемент – водород. Его условно размещают в IA или VIIA подгруппе, так как он проявляет сходство и со щелочными металлами, и с галогенами. Сходство водорода со щелочными металлами проявляется в том, что водород, как и щелочные металлы является восстановителем и, отдавая один электрон, образует однозарядный катион. Больше общего у водорода с галогенами: водород, как и галогены неметалл, его молекула двухатомна, он может проявлять окислительные свойства, образуя с активными металлами солеподобные гидриды, например, NaH, CaH₂.

В четвертом периоде вслед за Ca расположены 10 переходных элементов (декада Sc - Zn), за которыми находятся остальные 6 основных элементов периода (Ga - Kr). Аналогично построен пятый период. Понятие *переходный элемент* обычно используется для обозначения любого элемента с валентными d– или f–электронами.

Шестой и седьмой периоды имеют двойные вставки элементов. За элементом Ba расположена вставная декада d–элементов (La - Hg), причем после первого переходного элемента La следуют 14 f–элементов – *лантаноидов* (Ce - Lu). После Hg располагаются остальные 6 основных p–элементов шестого периода (Tl - Rn).

В седьмом (незавершенном) периоде за Ac следуют 14 f–элементов – *актиноидов* (Th - Lr). В последнее время La и Ac стали причислять соответственно к лантаноидам и актиноидам. Лантаноиды и актиноиды помещены отдельно внизу таблицы.

Таким образом, каждый элемент в периодической системе занимает строго определенное положение, которое отмечается *порядковым*, или *атомным*, номером [3].

В периодической системе по вертикали расположены восемь групп (I – VIII), которые в свою очередь делятся на подгруппы – *главные*, или подгруппы A и *побочные*, или подгруппы B. Подгруппа VIIIБ-особая, она содержит *триады* элементов, составляющих семейства железа (Fe, Co, Ni) и платиновых металлов (Ru, Rh, Pd, Os, Ir, Pt).

Сходство элементов внутри каждой подгруппы – наиболее заметная и важная закономерность в периодической системе. В главных подгруппах сверху вниз усиливаются металлические свойства и ослабевают неметаллические. При этом происходит увеличение устойчивости соединений элементов в низшей для данной подгруппы степени окисления. В побочных подгруппах – наоборот

– сверху вниз металлические свойства ослабевают и увеличивается устойчивость соединений с высшей степенью окисления.

Периодическая система и электронные конфигурации атомов

Поскольку при химических реакциях ядра реагирующих атомов не изменяются, то химические свойства атомов зависят от строения их электронных оболочек.

Заполнение электронных слоев и электронных оболочек атомов происходит в соответствии с принципом Паули и правилом Хунда.

Принцип Паули (запрет Паули)

Два электрона в атоме не могут иметь четыре одинаковых квантовых числа (на каждой атомной орбитали может находиться не более двух электронов).

Принцип Паули определяет максимальное число электронов, обладающих данным главным квантовым числом n (т.е. находящихся на данном электронном слое): $N_n = 2n^2$. На первом электронном слое (энергетическом уровне) может быть не больше 2 электронов, на втором – 8, на третьем – 18 и т. д.

В атоме водорода, например, имеется один электрон, который находится на первом энергетическом уровне в $1s$ – состоянии. Спин этого электрона может быть направлен произвольно ($m_s = +1/2$ или $m_s = -1/2$). Следует подчеркнуть еще раз, что первый энергетический уровень состоит из одного подуровня – $1s$, второй энергетический уровень – из двух подуровней – $2s$ и $2p$, третий – из трех подуровней – $3s$, $3p$, $3d$ и т.д. Подуровень, в свою очередь, содержит орбитали, число которых определяется побочным квантовым числом l и равно $(2l + 1)$. Каждая орбиталь условно обозначается клеткой, находящийся на ней электрон – стрелкой, направление которой указывает на ориентацию спина этого электрона.

Расположение спинов определяется правилом Хунда, которое гласит: заполнение энергетических уровней происходит таким образом, чтобы суммарный спин был максимальным.

В атоме каждый электрон занимает свободную орбиталь с наиболее низкой энергией, отвечающей его наибольшей связи с ядром. В 1961 г. В.М. Клечковский сформулировал общее положение, согласно которому энергия электронных орбиталей возрастает в порядке увеличения суммы главного и побочного квантовых чисел ($n + l$), причем в случае равенства этих сумм, меньшей энергией обладает орбиталь с меньшим значением главного квантового числа n [5, 7].

Определение валентности

Согласно по электронным формулам, все элементы VI A и VI B групп имеют электронные конфигурации законченные на p^4 и d^{4-5} . В рамках электронной теории валентность атома определяется на основании числа непарных электронов, которые участвуют в образовании электронных пар с электронами других атомов.

В образовании химических связей участвуют только электроны, находящиеся на внешней оболочке атома. Поэтому максимальная валентность химического элемента – это число электронов во внешней электронной оболочке его атома.

Исходя из этого, все элементы VI A и VI B групп показывают разные валентности: II, III, IV, V, VI.

А в случаях этих трех элементов их валентность определяется явлением «проскока». Явление «проскока» представляет собой символическое перенесение одного из двух валентных s -электронов на d -подуровень, что отражает неравномерность удержания ядром внешних электронов.

Определение способности вступать в реакцию элемента с другими элементами, причина ограниченности реакции химических элементов VI A и VI B групп

Внешним уровнем атома называется самый далекий от ядра уровень, на котором еще есть электроны. Именно эта оболочка соприкасается при столкновении с внешними уровнями других атомов в химических реакциях. При взаимодействии с другими атомами кислород способен принять 2 дополнительный электрон на свой внешний уровень. При этом атом кислорода получит *завершенный*, то есть максимально заполненный внешний электронный уровень, на котором расположатся 6 электронов. И этим объясняется причина ограниченности реакции химических элементов. Исходя из этого, правила Гунда является аналогичным и для всех элементов этой группы.

Характеристики химических элементов закономерно изменяются в группах и периодах [13].

Поскольку химическая связь, строение атома, электронные оболочки атома влияют на свойства элемента, то способность вступать в реакцию элемента тоже зависят от этих факторов. Например, молекула кислорода состоит из двух атомов. Химическая связь ковалентная неполярная[].

Кислород отличается высокой реакционной способностью, он окисляет многие вещества уже при комнатной температуре. Кислород образует соединения со всеми химическими элементами, кроме гелия, неона и аргона. С большинством элементов он взаимодействует непосредственно, кроме галогенов, за исключением фтора, золота и платины.

Определение способности вступать в реакцию элемента с другими элементами, причина ограниченности реакции химических элементов лантаноидов

Лантаноиды – это 14 элементов, следующих за лантаном, у которых к электронной конфигурации лантана последовательно добавляются 14 4f-электронов. В табл. 8.12 приведены электронные конфигурации лантаноидов и их наиболее устойчивые степени окисления [8]. Общая электронная конфигурация лантаноидов – $4f^{2-14}5d^{0-1}6s^2$.

Интерактивизация и виртуализация на компьютере таблицы Менделеева и химических соединений элементов в программной среде Flash-CC, Java- script. Анимационные образы в движении и работа с ними требует большого объема памяти. А для сокращения емкости памяти, использование для виртуальной –интерактивизаций процессов, Flash является очень эффективным. [14-17]. От основного векторно – графического формата Flash технологий сформировалась Shorewave Flash (SWF) – ответвление. Но, это не первый векторный формат, это механизм передачи Web – страницы к SWF как нахождение графического изображения, согласующего звена инструментального оборудования и графического изображения. Преимущество SWF- приложения это его легко переносимость в другую среду, т.е. этот формат используется в разных информационно – программной платформе (в операционной системе Mac OS Macintosh, в ОС -Windows OS). Еще одна особенность SWF – построенные основные изображения не только принимают анимацию но и дополнительно, возможность создавать интерактивные элементы и аудио установки, а из них формировать интерактивную виртуальную лабораторию, очень удобны форматы SWF, CC – программной среды Flash. Еще одна причина популярности SWF – формата это очень легкое и удобное применение инструментов для других платформ разработка фирмы Macromedia. Например:-для создания мультимедийных презентаций применяют программный аппарат – Macromedia Director Shockwave Studio, - а для создания графических образов применяются программный аппарат – Macromedia Authorwave, Macromedia Course Builder. Поэтому среди Web – публикации самое узнаваемое и легко применяемая публикация это Macromedia Flash Web – дает возможность украсить каждый сайт анимацией и собрать полную страницу. Action Script Tools - позволяет Web- дополнение собрать эффективно и его новые языки аналогично похоже на сценарий Java Script, Action Script и с помощью редактора Devigger является решением часто применяемых элементов. Для виртуализации и интерактивизации электронных орбиталей, электронных конфигурации по каждому элементу таблицы Менделеева выбрана компьютерно-програмная среда в формате CC – программной среды Flash и Web- дополнение сценарий Java Script, Action Script и с помощью редактора Devigger. По каждому элементу таблицы Менделеева создавалось электронная конфигурация согласно закону Гунда. По правилу Гунда при заполнении электронами одинаковых по энергии орбиталей электроны располагаются в первую очередь по одиночке на каждой орбитали, и лишь потом начинается заселение этих орбиталей вторыми электронами.

Например электронная формула кислорода несет очень важную информацию: внешний электронный уровень кислорода заполнен электронами не до конца (на нем $4+ 2= 6$ электронов) и до полного заполнения не хватает два электрона. Общий вид виртуально-интерактивной таблицы в названной программной среде приведен на рисунке-1. При нажатии любой кнопки автоматически изображаются в движущейся динамике электронные конфигурации любого химического элемента в плоском-2D и объемном- 3D формате, а также последовательность энергетических уровней в порядке возрастания энергии по следующей схеме:

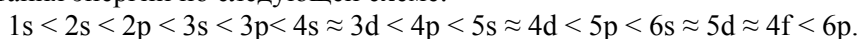

В данной таблице Менделеева рисунка-1 приведены атомные массы, валентности, количество нейтронов, русское и английское наименование и электронные формулы для I (A, B) группы элементов. А также для каждого химического элемента I (A, B) группы приведены порядковые номера и электронные формулы в виде рисунков. Как указано в рисунке-1, порядковый номер химического элемента является атомным номером. Оно равно количеству протонов. Символом протона является Z. Для определения нейтрона используется формула:

$N = A - Z$ [9]. Исходя из формулы энергетических уровней и определяется способность химических элементов к химическим реакциям или соединениям.



Рисунок 1- Виртуально-интерактивная периодическая таблица химических элементов Д.И.Менделеева



Рисунок 2 – Плоская картина электронных орбиталей элемента «Сиборгий» в движении, атомная масса, валентность, количество нейтронов и протонов, электронная формула энергетических уровней орбиталей

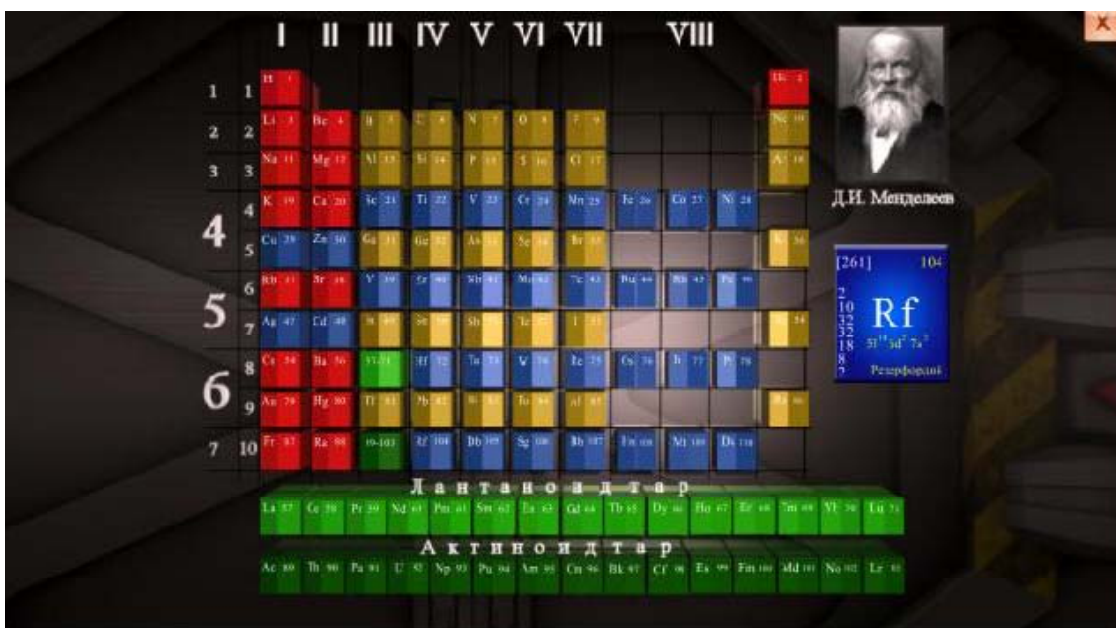

Рисунок 3 - Объемная картина электронных орбиталей элемента «Сиборгий» в движении, атомная масса, валентность, количество нейтронов и протонов, электронная формула энергетических уровней орбиталей

Вывод

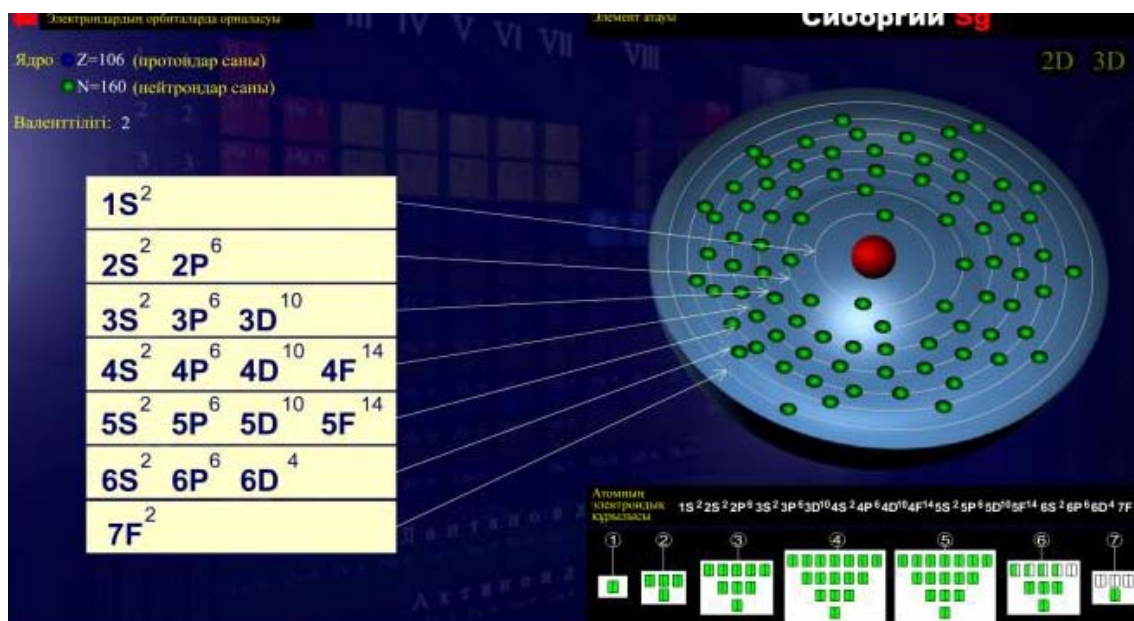
Создана виртуально-интерактивная-мультимедийная таблица периодической системы элементов Д.И. Менделеева на электронном носителе, как видно из данной таблицы, из формулы энергетических уровней и определяется способность химических элементов к химическим реакциям или к химическому соединению с другими элементами. На основе исследования планируются практические применения результатов виртуально-управляемой (интерактивная) лаборатории с визуализацией и анимацией механизмов протекания процессов, по неорганической и органической химии. Будут применяться для повышения качества обучения, большой экономии времени (около 60% на усвоение предмета), для самостоятельного проведения исследовательских работ, для развития творчества обучающихся. Продукт будут использовать вся система среднего образования (школы, лицеи, гимназии), вся система высшего образования, где изучают химию, научно-исследовательские институты и лаборатории, а также пищевая, химическая, фармацевтическая, другие технологические индустрии.

ЛИТЕРАТУРА

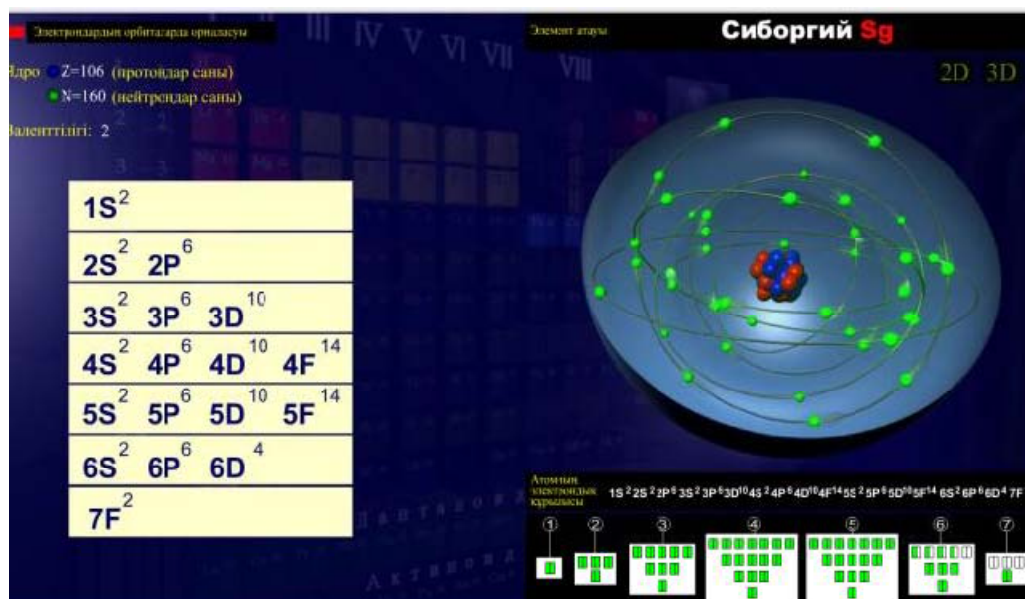
- [1] Периодический закон химических элементов // Энциклопедический словарь юного химика. 2-е изд. / Сост. В. А. Крицман, В. В. Станцо. - М.: Педагогика, 1990. - С. 185. - ISBN 5-7155-0292-6.
- [2] http://m.itest.kz/leksiya_neorganicheskaya_khimiya_nemetally Некрасов Б. В., Основы общей химии, т. 1, 1973, с. 29.
- [3] Реми Г., Курс неорганической химии, т. 1, 1963, с. 29.
- [4] Messler R. W. The essence of materials for engineers. - Sudbury, MA: Jones & Bartlett Publishers, 2010. - P. 32.- ISBN 0763778338.
- [5] Агафшин Н. П. Периодический закон и периодическая система элементов Д. И. Менделеева. - М.: Просвещение, 1973. — 208 с.
- [6] Евдокимов Ю., К истории периодического закона. Наука и жизнь, № 5 (2009), - С. 12-15.
- [7] Макареня А. А., Рысев Ю. В. Д. И. Менделеев. - М.: Просвещение, 1983. - 128 с.
- [8] Макареня А. А., Трифонов Д. Н. Периодический закон Д. И. Менделеева. - М.: Просвещение, 1969. - 160 с.
- [9] Некрасов Б.В. Основы общей химии. - 3-е изд. - М.: Химия, 1973. - Т. 1. - 656 с.
- [10] Реми Г. Курс неорганической химии. - М.: Изд-во иностранной лит-ры, 1963. -Т. 1. - 920 с.
- [11] Ахметов Н.С. Общая неорганическая химия. . - М.: 2001. - 743 с.
- [12] [va_gruppy_i_ikh_soedineniya_ru](#)

- [13] <http://www.alhimikov.net/elektronbuch/Page-6.html>
- [14] Adambek Tatenov, Akerke Shiynkulovna Amirkhanova, Victoria Viacheslavovna Savelyeva
- [15] Virtual-interactive visualization of atomic structures, electron configurations, energy levels in 3D format for the construction of virtual-interactive laboratories with the mechanisms of chemical reactions in inorganic and organic chemistry.- International Journal of Applied Engineering Research ISSN 0973-4562 Volume 11, Number 5 (2016) pp 3319-3321 © Research India Publications. <http://www.ripublication.com> 3319
- [16] Дронов В. Macromedia Flash MX. Экспресс-курс; БХВ-Петербург - Москва, 2003.-344с.
- [17] Никифорова Н. Г., Федоровская Р. А., Никифоров А. В. Работа в среде MacromediaFlash5; ИВЭСЭП-Москва, 2008.- 899 с.
- [18] Tatenov A.M., Askarova Sh.M. Virtual and Interactive Information Technology in Modeling Researches of Processes of Applied Problems of a Science. World Applied Sciences Journal, -30.(Management, Economics, Technology), 2014, pp.-144-148. ISSN.1818-4952.

УДК 542.8:544.14:539.19

А.М. Тәтенов, В.В. Савельева, А.С. Калиев

Еуразия технологиялық университеті, Алматы қ., Қазақстан

**Д.И.МЕНДЕЛЕЕВ ТАБЛИЦАСЫНДАҒЫ ХИМИЯЛЫҚ ЭЛЕМЕНТТЕРДІҢ ҚОСЫЛУ
МЕХАНИЗМДЕРІН FLASH-CC, JAVA SCRIPT-БАҒДАРЛАМАЛЫҚ ОРТАЛАРЫНДА
ВИРТУАЛДАП-ИНТЕРАКТИВТЕНДІРУ**

Аннотация. Органикалық емес химиядан химиялық реакциялардың тереңдетілген механизмін көрнекілеу мақсатында виртуалды-интерактивті зертханалар жасауды сұрақ ретінде мақалада қойып отыр.

Осы зерттеулер нәтижесінде, органикалық және органикалық емес химиядан жасалған виртуалды-интерактивті зертханалар көмегімен көрнекіленген және анимацияланған реакция процесстерінің механизмін тәжірибе жүзінде қолданысқа жіберу көзделіп отыр. Бұндай қолданыс оқу сапасын арттыру мақсатында, оқу уақытын үнемдеуге (пәндерді меңгеруге кететін уақытты -60%-ға дейін), өз бетімен зерттеу жұмыстарын жүргізуге, оқушылардың шығармашылық қабілетін арттыруға көмектеседі. Жоба нәтижесін барлық білім салалары қолданады; мектептер, лицейлер, гимназиялар, химияны оқитын барлық жоғары білім жүйесі, ғылыми-зерттеу институттары, зертханалары, фармацевтика, химия, тамақ индустриялары.

Түйін сөздер: элементтердің периодтық жүйесі, атом, электрон, протон, нейтрон, атомдық масса, Паули принципі, Хунд ережесі, орбиталь, энергетикалық деңгейлер, валенттілік.

МАЗМҰНЫ

<i>Уразов К.А., Дергачева М.Б., Гременок В.Ф.</i> Полианалин қабықшаларының беткі морфологиясын зерттеу (ағылшын тілінде).....	6
<i>Тунгатарова С.А., Ксандопуло Г., Байжуманова Т.С., Жумабек М., Кауменова Г.Н., Амренова Н.А., Салиманова А.К., Райысов А.</i> Метанды синтез-газға Ni-Co-Mg-Ce катализаторлары қатысында құрғақ реформингілеу мен тотықтыру конверсиясы (ағылшын тілінде).....	13
<i>Леска Б., Тукибаева А., Калиева Н.</i> Күмістің бетінде адсорбцияланған Si-органикалық қосылыстар монокабаттарының құрылымы және электрохимиялық реакциялық қабілеттері (ағылшын тілінде).....	20
<i>Силачёв И. Ю.</i> Анализ редкоземельных металлов в урановом сырьё нейтронно-активационным и рентгенофлуоресцентным методами (ағылшын тілінде).....	28
<i>Қасенова Ш.Б., Қасенов Б.Қ., Сағынтаева Ж.И., Тұртұбаева М.О., Қуанышбеков Е.Е.</i> Лантан және сілтілі металдардың жаңа наноөлшемді (нанокластерлік) кобальт-купрат-манганиттері және оларды рентгенографиялық тұрғыдан зерттеу (ағылшын тілінде).....	39
<i>Сағынтаева Ж.И., Қасенов Б.Қ., Қасенова Ш.Б., Тұртұбаева М.О., Қуанышбеков Е.Е.</i> Жаңа наноөлшемді (нанокластерлік) никелит-купрат-манганиттердің синтезі және рентгенографиясы (ағылшын тілінде).....	44
<i>Буканова А.С., Қайыршева Ф.Б., Сақипова Л.Б., Панченко О.Ю., Қарабасова Н.А., Насиров Р.Н.</i> Тотығу – тотықсыздану реакцияларының жаңа қолданылуы (ағылшын тілінде).....	49
<i>Тәтенов А.М., Савельева В.В., Калиев А.С.</i> Д.И. Менделеев таблицасындағы химиялық элементтердің қосылу механизмдерін Flash-CC, Java script-бағдарламалық орталарында виртуалдап-интерактивтендіру (ағылшын тілінде).....	55
<i>Алтыбаев Ж.М., Шапалов Ш.К., Битемирова А.Е., Жанмулдаева Ж.К., Айтуреев М.Ж., Кенжибаева Г.С., Суйгенбаева А.Ж., Изтилеуов Г.</i> Фосфатты-кремнийлі ұсақты флюстеуші қоспалармен агломерациялау мүмкіндігін термодинамикалық зерттеу (ағылшын тілінде).....	61

* * *

<i>Қасенова Ш.Б., Қасенов Б.Қ., Сағынтаева Ж.И., Тұртұбаева М.О., Қуанышбеков Е.Е.</i> Лантан және сілтілі металдардың жаңа наноөлшемді (нанокластерлік) кобальт-купрат-манганиттері және оларды рентгенографиялық тұрғыдан зерттеу (орыс тілінде).....	67
<i>Сағынтаева Ж.И., Қасенов Б.Қ., Қасенова Ш.Б., Тұртұбаева М.О., Қуанышбеков Е.Е.</i> Жаңа наноөлшемді (нанокластерлік) никелит-купрат-манганиттердің синтезі және рентгенографиясы (орыс тілінде).....	73
<i>Тәтенов А.М., Савельева В.В., Калиев А.С.</i> Д.И. Менделеев таблицасындағы химиялық элементтердің қосылу механизмдерін Flash-CC, Java script-бағдарламалық орталарында виртуалдап-интерактивтендіру (ағылшын тілінде).....	79

СОДЕРЖАНИЕ

<i>Уразов К.А., Дергачева М.Б., Гременок В.Ф.</i> Исследование морфологии поверхности пленок полианалина (на английском языке)	6
<i>Тунгатарова С.А., Ксандопуло Г., Байжуманова Т.С., Жумабек М., Кауменова Г.Н., Амренова Н.А., Салиманова А.К., Райысов А.</i> Сухой реформинг и окислительная конверсия метана в синтез-газ в присутствии Ni-Co-Mg-Ce катализаторов (на английском языке).....	13
<i>Леска Б., Тукибаева А., Калиева Н.</i> Структура и электрохимическая реакционная способность монослоев Si-органических соединений, адсорбированных на поверхности серебра (на английском языке).....	20
<i>Силачѳв И.Ю.</i> Нейтрон-активациялык жѳне рентгенфлуоресценттік эдістері арқылы урандык шикізаттагы жерде сирек кездесетін металдарды талдау (на английском языке).....	28
<i>Касенова Ш.Б., Касенов Б.К., Сагинтаева Ж.И., Туртубаева М.О., Куанышбеков Е.Е.</i> Новые наноразмерные (нанокластерные) кобальто-купрато-манганиты лантана и щелочных металлов и их рентгенографическое исследование (на английском языке)	39
<i>Сагинтаева Ж.И., Касенов Б.К., Касенова Ш.Б., Туртубаева М.О., Куанышбеков Е.Е.</i> Синтез и рентгенография новых наноразмерных (нанокластерных) никелито-купрато-манганитов лантана и щелочных металлов (на английском языке).....	44
<i>Буканова А.С., Кайрлиева Ф.Б., Сакипова Л.Б., Панченко О.Ю., Карабасова Н.А., Насиров Р.Н.</i> Новое применение окислительно-восстановительных реакций (на английском языке).....	49
<i>Татенов А.М., Савельева В.В., Калиев А.С.</i> Механизм соединения химических элементов таблицы Д.И.Менделеева и виртуальная интерактивизация в программной среде Flash-CC, Java script. (на английском языке).....	55
<i>Алтыбаев Ж.М., Шапалов Ш.К., Битемирова А.Е., Джанмулдаева Ж.К., Айтуреев М.Ж., Кенжибаева Г.С., Суйгенбаева А.Ж., Изтилеуов Г.</i> Термодинамическое исследование возможности агломерации фосфатно-кремнистой мелочи с флюсующими добавками (на английском языке).....	61

* * *

<i>Касенова Ш.Б., Касенов Б.К., Сагинтаева Ж.И., Туртубаева М.О., Куанышбеков Е.Е.</i> Новые наноразмерные (нанокластерные) кобальто-купрато-манганиты лантана и щелочных металлов и их рентгенографическое исследование (на русском языке)	67
<i>Сагинтаева Ж.И., Касенов Б.К., Касенова Ш.Б., Туртубаева М.О., Куанышбеков Е.Е.</i> Синтез и рентгенография новых наноразмерных (нанокластерных) никелито-купрато-манганитов лантана и щелочных металлов (на русском языке).....	73
<i>Татенов А.М., Савельева В.В., Калиев А.С.</i> Механизм соединения химических элементов таблицы Д.И.Менделеева и виртуальная интерактивизация в программной среде Flash-CC, Java script. (на английском языке).....	79

CONTENTS

<i>Urazov K.A., Dergacheva M.B., Gremenok V.F.</i> Investigation of the surface morphology of polyaniline thin films (in English).....	6
<i>Tungatarova S.A., G. Xanthopoulou, Baizhumanova T.S., Zhumabek M., Kaumenova G.N., Amrenova N.A., Salimanova A.K., Raiyssov A.</i> Dry reforming and oxidative conversion of methane to synthesis gas in the presence of Ni-Co-Mg-Ce catalysts (in English).....	13
<i>Łęska B., Tukibayeva A., Kalieva N.</i> Structure and electrochemical reactivity OF Si-organic compounds monolayers adsorbed on silver surface (in English).....	20
<i>Silachyov I. Yu.</i> Determination of rare earths in uranium raw material by neutron activation analysis and x-ray fluorescence (in English).....	28
<i>Kasenova Sh.B., Kasenov B.K., Sagintaeva Zh.I., Turtubaeva M.O., Kuanyshbekov E.E.</i> New nano-sized (nanocluster) cobalt- cuprate -manganites of lanthane and alkaline metals and their X-ray diffraction study (in English).....	39
<i>Sagintaeva Zh.I., Kasenov B.K., Kasenova Sh.B., Turtubaeva M.O., Kuanyshbekov E.E.</i> Synthesis and X-ray of new nanosized (nanocluster) nickelite-cuprate-manganites of lanthanum and alkaline metals (in English).....	44
<i>Bukanova A.S., Kairlieva F.B., Sakipova L.B., Panchenko O.Yu., Karabasova N.A., Nasirov R.N.</i> New application of oxidation-reduction reactions (in English).....	49
<i>Tatenov A.M., Savelyeva V.V., Kaliev A.S.</i> The mechanism of compound of chemical elements for the table of D.I. Mendeleev and the virtual interaktivization in the program environment Flash-CC, Java script. (in English).....	55
<i>Altybayev Zh.M., Shapalov Sh.K., Bitemirova A.E., Dzhanmuldaeva Zh.K., Aitureyev M.Zh., Kenzhibayeva G.S., Suygenbayeva A.Zh., Iztileuov G.M.</i> Thermodynamic research of the possibility of phosphatic and siliceous fines sintering with the fluxing additives (in English).....	61

* * *

<i>Kasenova Sh.B., Kasenov B.K., Sagintaeva Zh.I., Turtubaeva M.O., Kuanyshbekov E.E.</i> New nano-sized (nanocluster) cobalt- cuprate -manganites of lanthane and alkaline metals and their X-ray diffraction study (in Russian).....	67
<i>Sagintaeva Zh.I., Kasenov B.K., Kasenova Sh.B., Turtubaeva M.O., Kuanyshbekov E.E.</i> Synthesis and X-ray of new nanosized (nanocluster) nickelite-cuprate-manganites of lanthanum and alkaline metals (in Russian).....	73
<i>Tatenov A.M., Savelyeva V.V., Kaliev A.S.</i> The mechanism of compound of chemical elements for the table of D.I. Mendeleev and the virtual interaktivization in the program environment Flash-CC, Java script. (in English).....	79

**Publication Ethics and Publication Malpractice
in the journals of the National Academy of Sciences of the Republic of Kazakhstan**

For information on Ethics in publishing and Ethical guidelines for journal publication see <http://www.elsevier.com/publishingethics> and <http://www.elsevier.com/journal-authors/ethics>.

Submission of an article to the National Academy of Sciences of the Republic of Kazakhstan implies that the described work has not been published previously (except in the form of an abstract or as part of a published lecture or academic thesis or as an electronic preprint, see <http://www.elsevier.com/postingpolicy>), that it is not under consideration for publication elsewhere, that its publication is approved by all authors and tacitly or explicitly by the responsible authorities where the work was carried out, and that, if accepted, it will not be published elsewhere in the same form, in English or in any other language, including electronically without the written consent of the copyright-holder. In particular, translations into English of papers already published in another language are not accepted.

No other forms of scientific misconduct are allowed, such as plagiarism, falsification, fraudulent data, incorrect interpretation of other works, incorrect citations, etc. The National Academy of Sciences of the Republic of Kazakhstan follows the Code of Conduct of the Committee on Publication Ethics (COPE), and follows the COPE Flowcharts for Resolving Cases of Suspected Misconduct (http://publicationethics.org/files/u2/New_Code.pdf). To verify originality, your article may be checked by the Cross Check originality detection service <http://www.elsevier.com/editors/plagdetect>.

The authors are obliged to participate in peer review process and be ready to provide corrections, clarifications, retractions and apologies when needed. All authors of a paper should have significantly contributed to the research.

The reviewers should provide objective judgments and should point out relevant published works which are not yet cited. Reviewed articles should be treated confidentially. The reviewers will be chosen in such a way that there is no conflict of interests with respect to the research, the authors and/or the research funders.

The editors have complete responsibility and authority to reject or accept a paper, and they will only accept a paper when reasonably certain. They will preserve anonymity of reviewers and promote publication of corrections, clarifications, retractions and apologies when needed. The acceptance of a paper automatically implies the copyright transfer to the National Academy of Sciences of the Republic of Kazakhstan.

The Editorial Board of the National Academy of Sciences of the Republic of Kazakhstan will monitor and safeguard publishing ethics.

Правила оформления статьи для публикации
в журнале смотреть на сайте:

www.nauka-nanrk.kz

<http://www.chemistry-technology.kz/index.php/ru/>

ISSN 2518-1491 (Online), ISSN 2224-5286 (Print)

Редакторы: *М. С. Ахметова, Т. А. Апендиев, Аленов Д.С.*
Верстка на компьютере *А.М. Кульгинбаевой*

Подписано в печать 13.06.2018.
Формат 60x881/8. Бумага офсетная. Печать – ризограф.
5,6 п.л. Тираж 300. Заказ 3.